



< Scribed Brass Parts : 199Pcs. >

66600 1/200 TITANIC DETAIL UP SET

- Brass01 Crane A+B : 8Pcs.
- Brass02 Crane C : 8Pcs.
- Brass03 Capstan : 8Pcs.
- Brass04 Capstan Wildcat : 8Pcs.
- Brass05 Telegraph Dial : 7Pcs.
- Brass06 Telegraph Dial Pedestal : 7Pcs.
- Brass07 Motion Shaft : 2Pcs.
- Brass08 Anchor Cover : 2Pcs.
- Brass09 Anchor Gear A+B+C : 2Pcs.
- Brass10 Windlass : 2Pcs.
- Brass11 Docking Flag Staff : 2Pcs.
- Brass12 Bridge Wheel Pedestal AB : 2Pcs.
- Brass13 Morse A +Navigation Lamp B : 2Pcs.
- Brass14 Sounding Spar Boom : 2Pcs.
- Brass15 20ft. T-Antenna Beam : 2Pcs.
- Brass16 Steam Supply Pipe : 2Pcs.
- Brass17 Steam Supply Valve A+A+A : 1Pc.
- Brass18 FairLead Wheel : 24Pcs.
- Brass19 Bollard : 28Pcs.
- Brass20 Welldeck Bollard : 16Pcs.
- Brass21 Winch C : 16Pcs.
- Brass22 Winch A : 6Pcs.
- Brass23 Winch B : 3Pcs.
- Brass24 Winch D : 3Pcs.
- Brass25 Telephone Box Base : 3Pcs.
- Brass26 Anchor Crane Axis A+B : 1Pc.
- Brass27 Anchor Crane Arm : 1Pc.
- Brass28 Anchor Crane Base : 1Pc.
- Brass29 Flag Staff : 1Pc.
- Brass30 Aft. Mast 1 : 1Pc.
- Brass31 Aft. Mast 2 : 1Pc.
- Brass32 Aft. Mast 3 : 1Pc.
- Brass33 Derrick A+ Docking Lamp B : 1Pc.
- Brass34 Fore Mast 1 : 1Pc.
- Brass35 Fore Mast 2 : 1Pc.
- Brass36 Fore Mast 3 : 1Pc.
- Brass37 Bell 25in : 1Pc.
- Brass38 Bell 15in : 1Pc.

< Metal Screws >

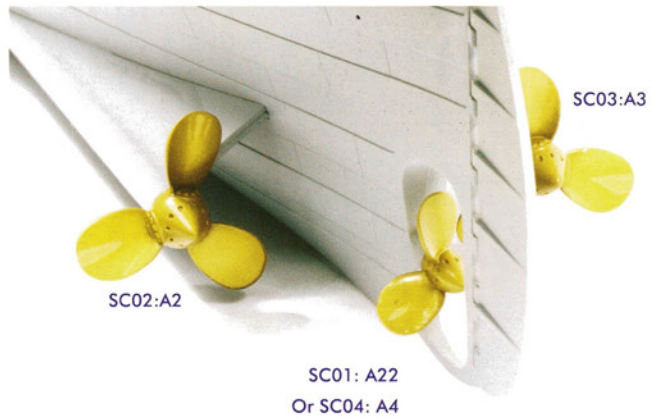
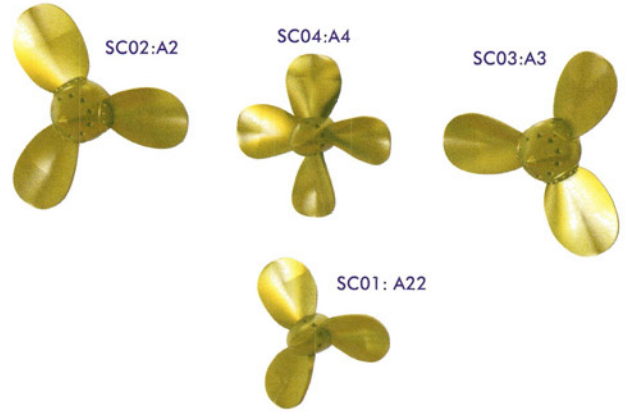

< Wooden Deck : 8 Sheets A-H >

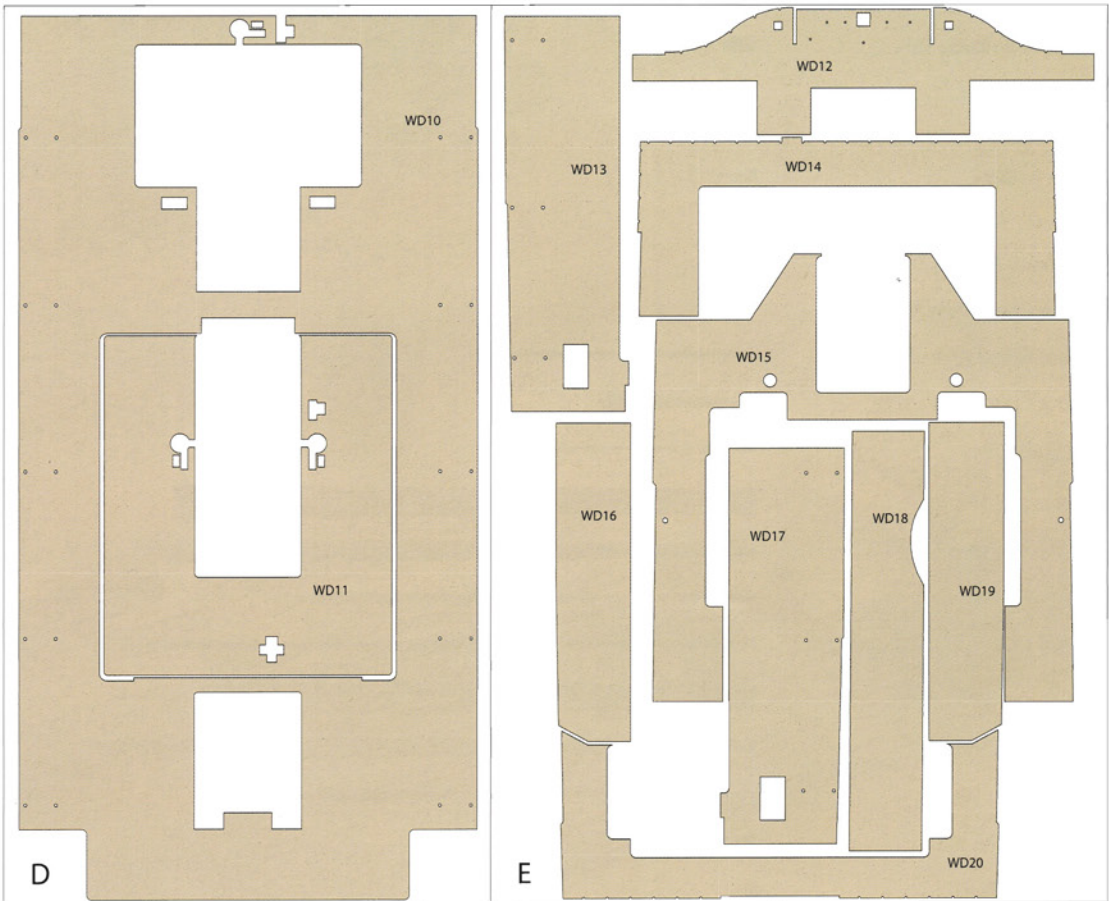
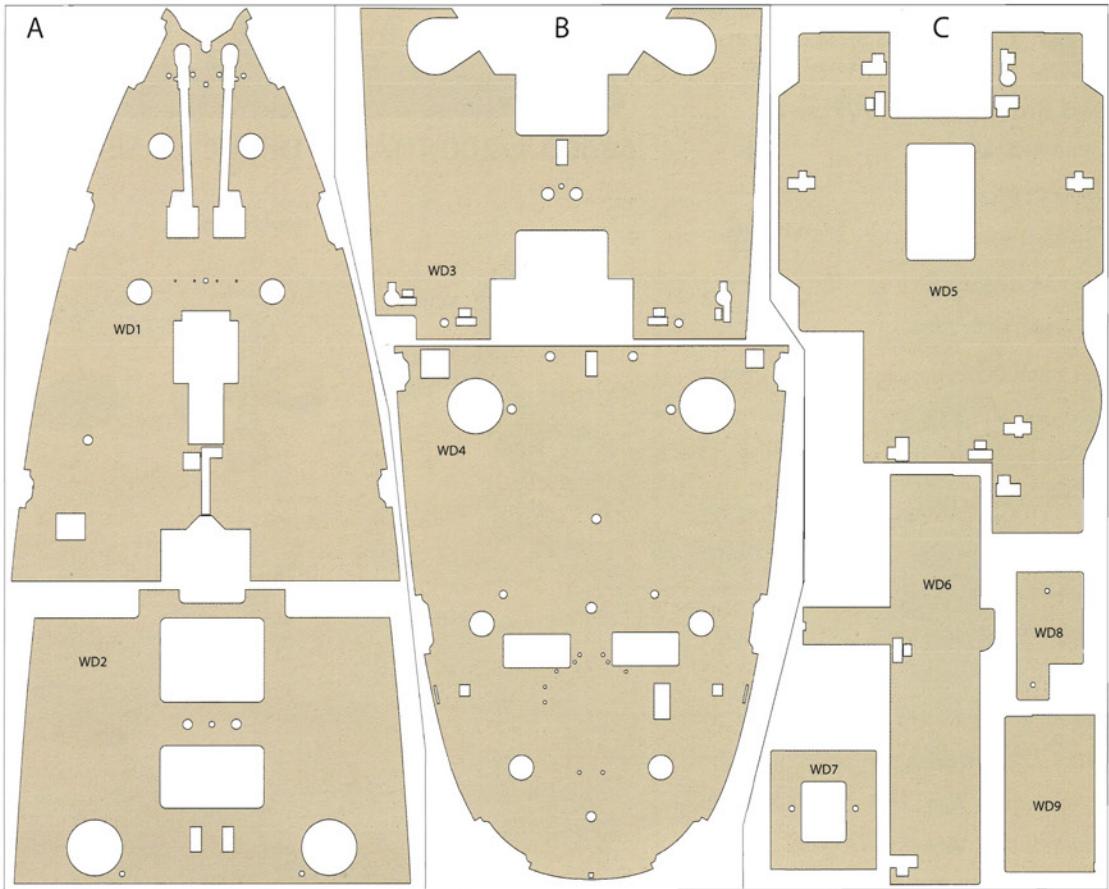

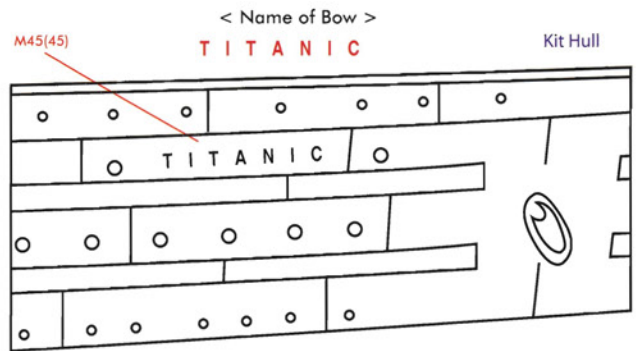
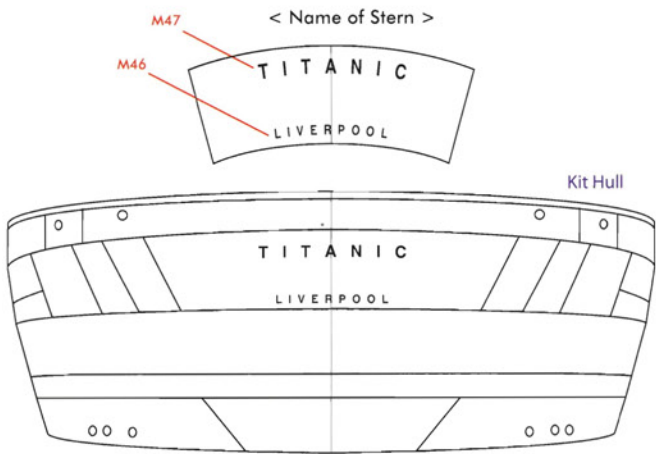
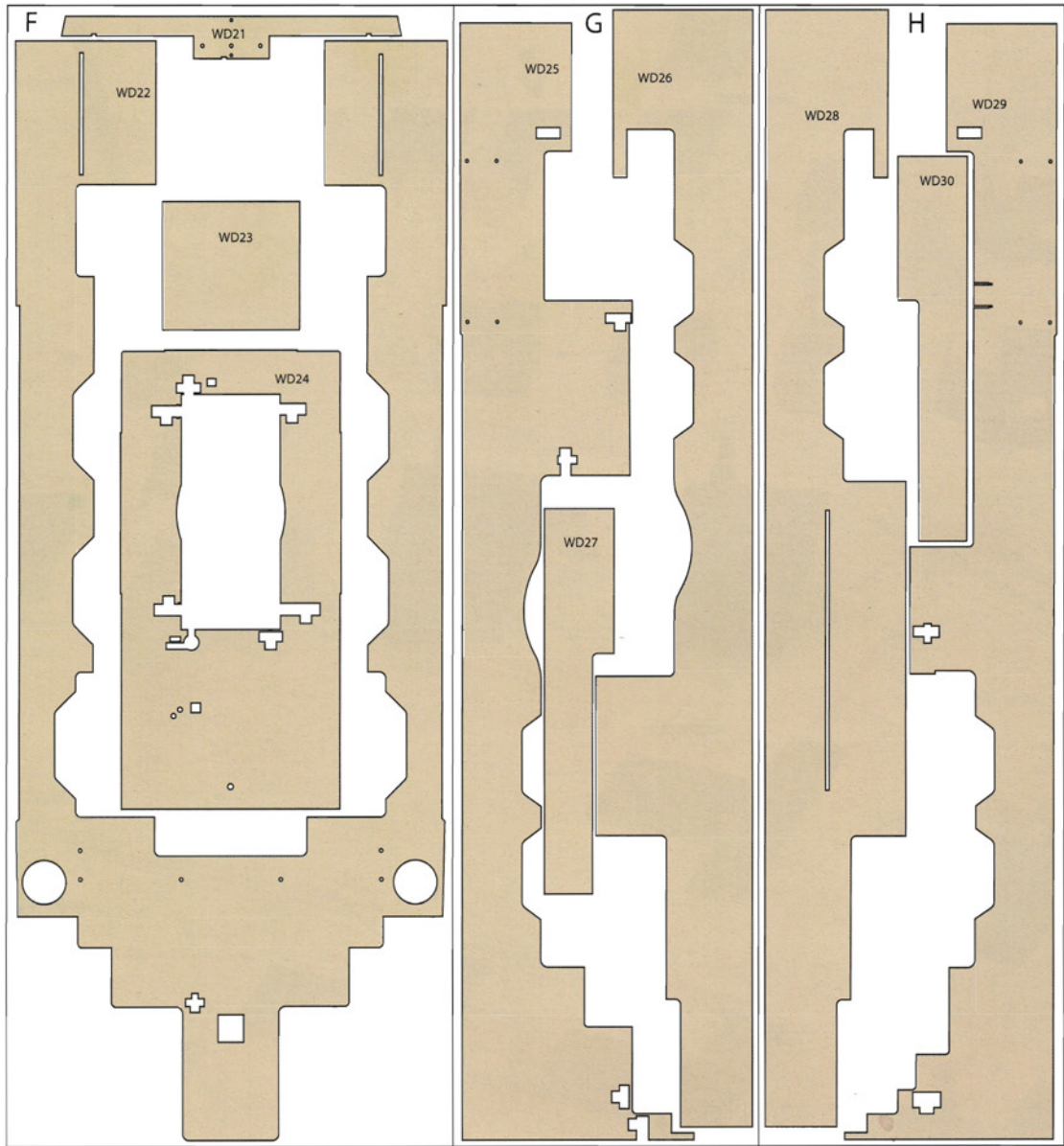

< Fore Mast >

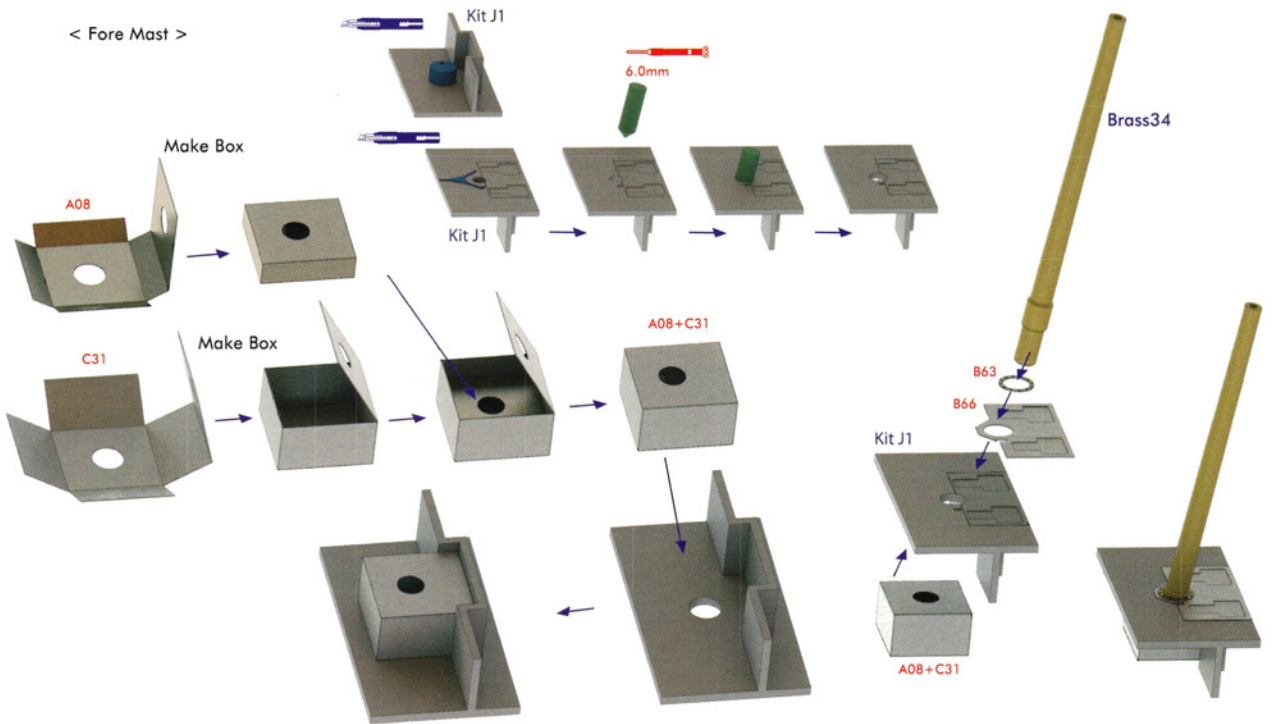

< After Mast >

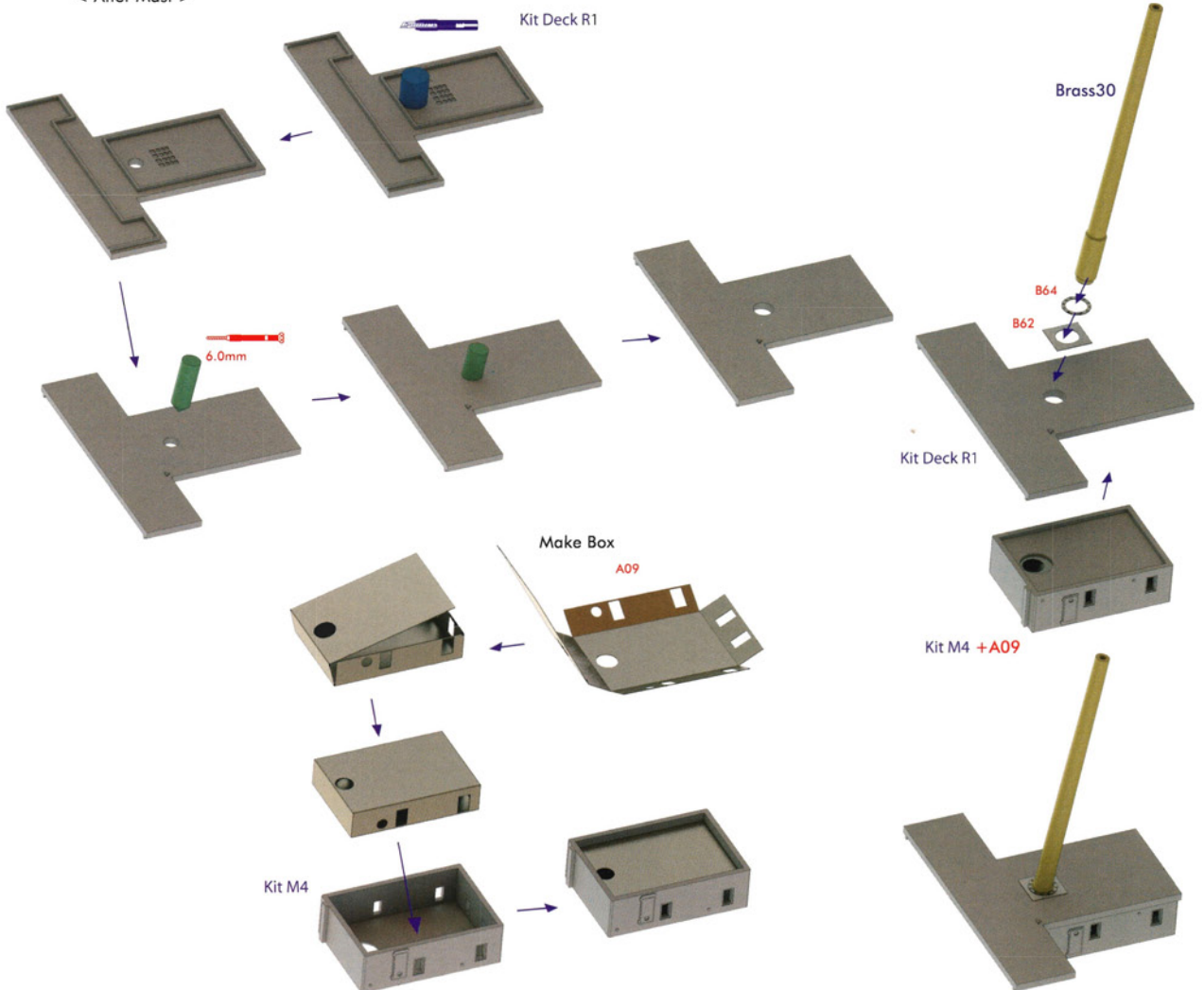

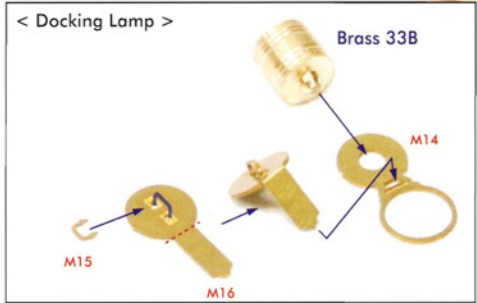
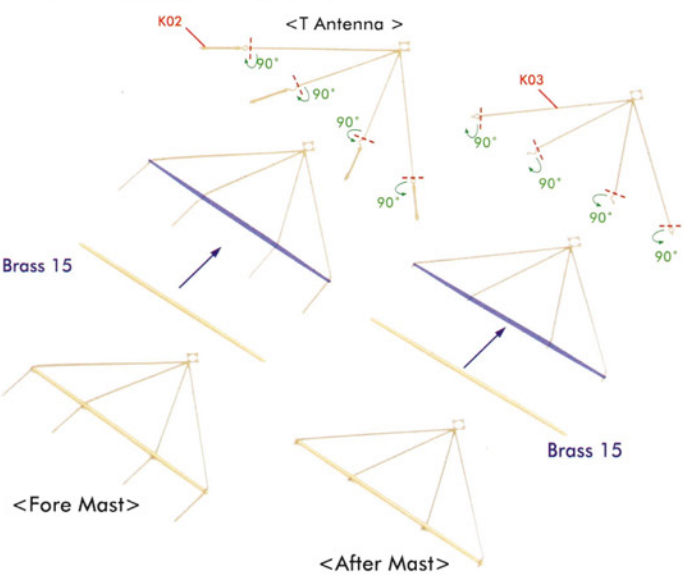
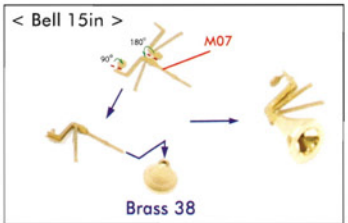
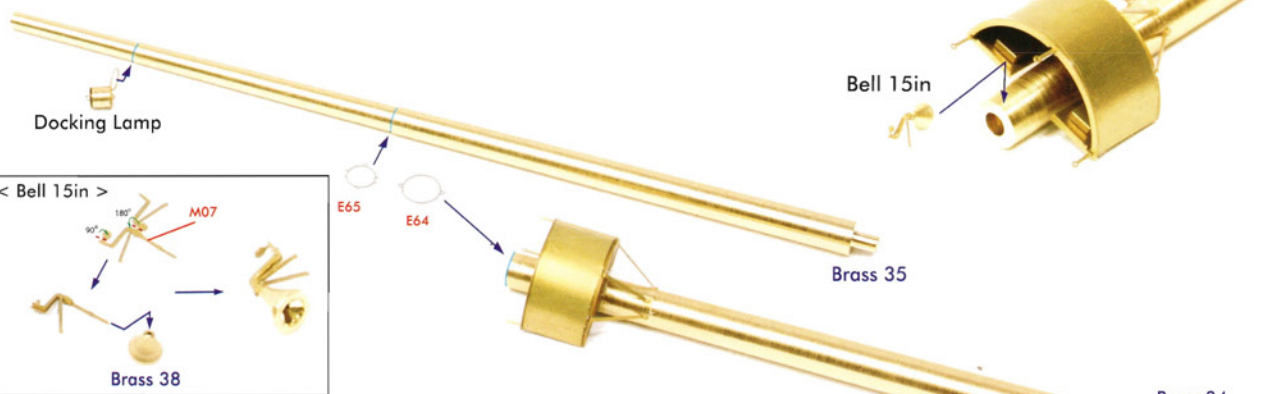
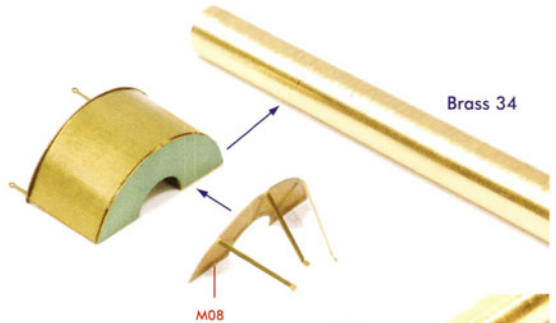
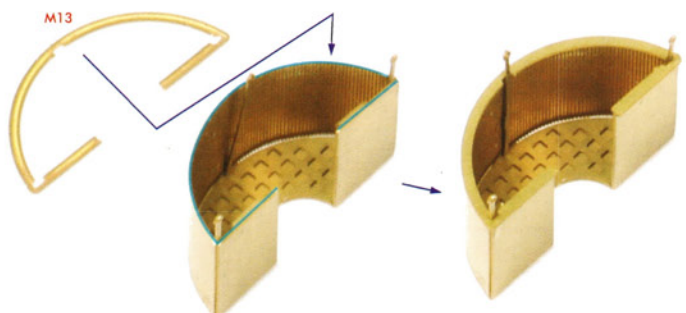
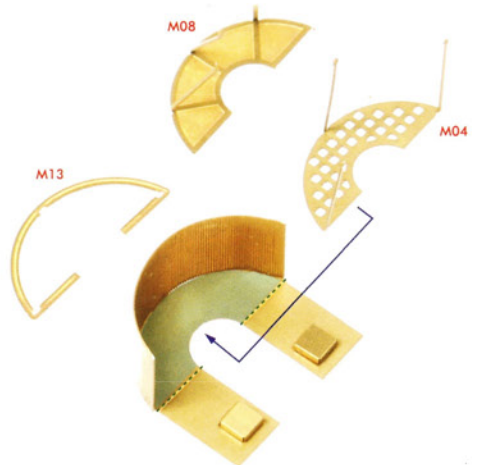
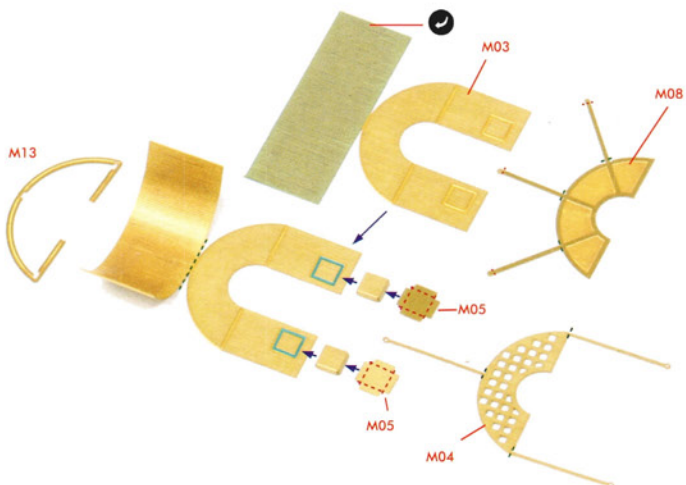

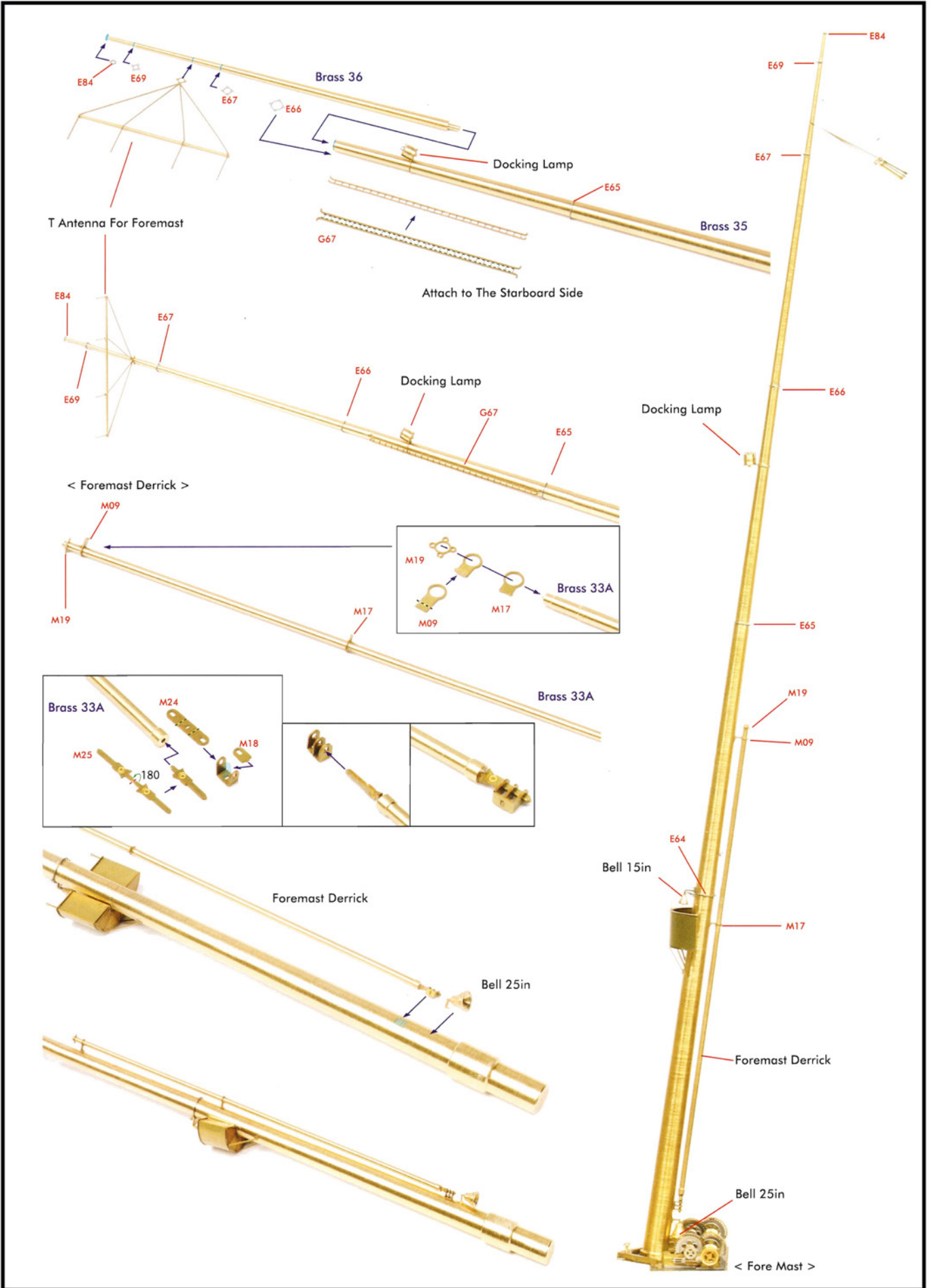

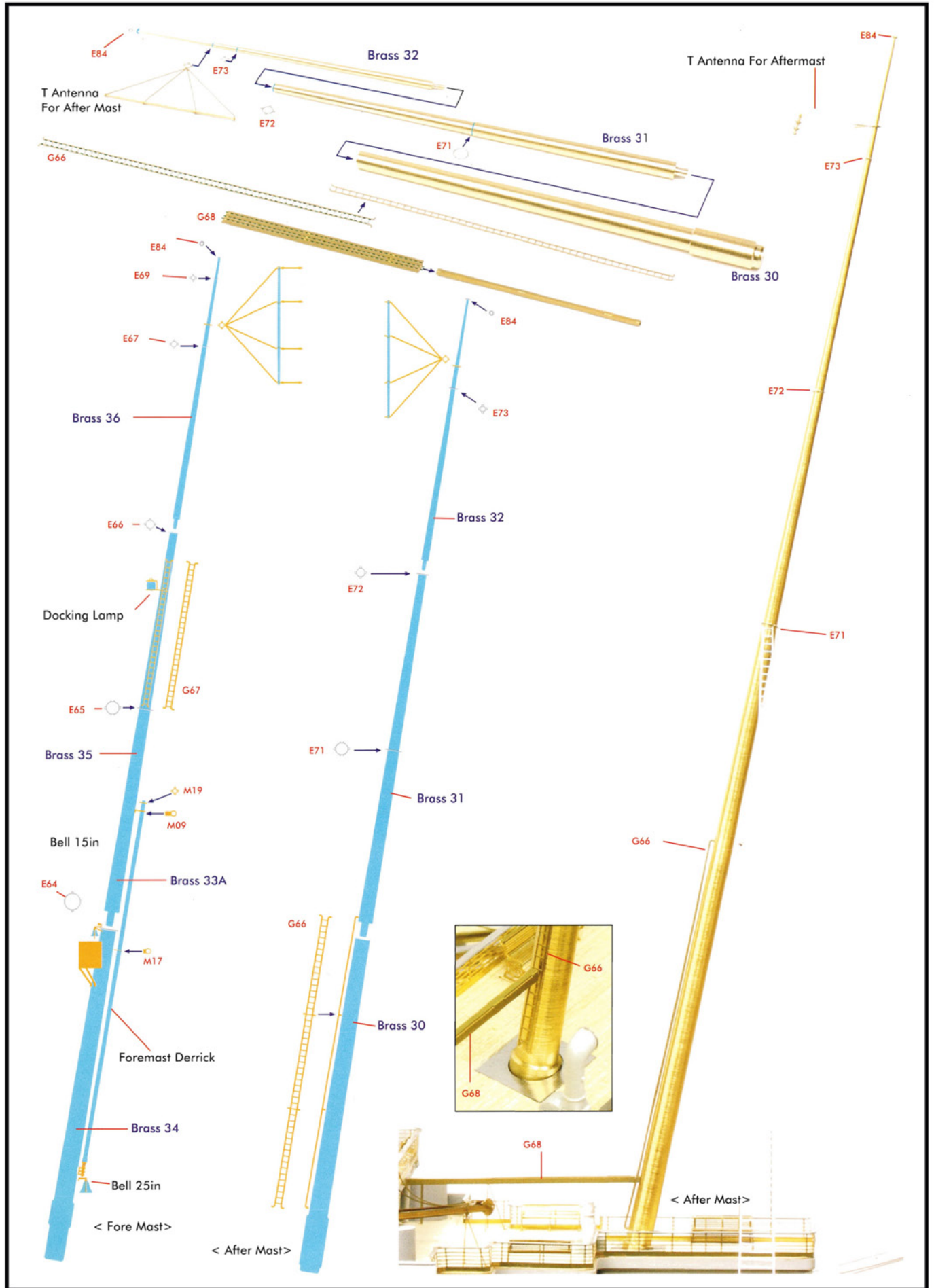

Kit J1

Kit W1

< Capstan >

F27 < Telephone Box >

< Wildcat Controller >

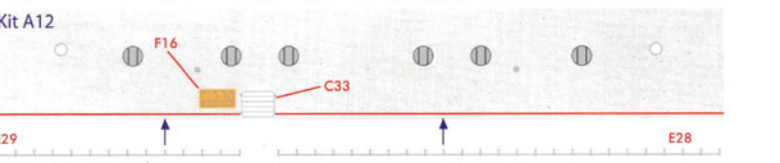
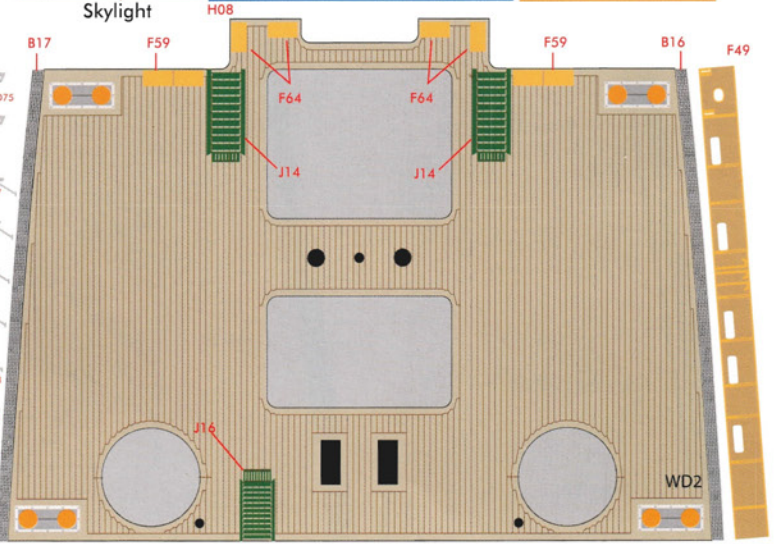
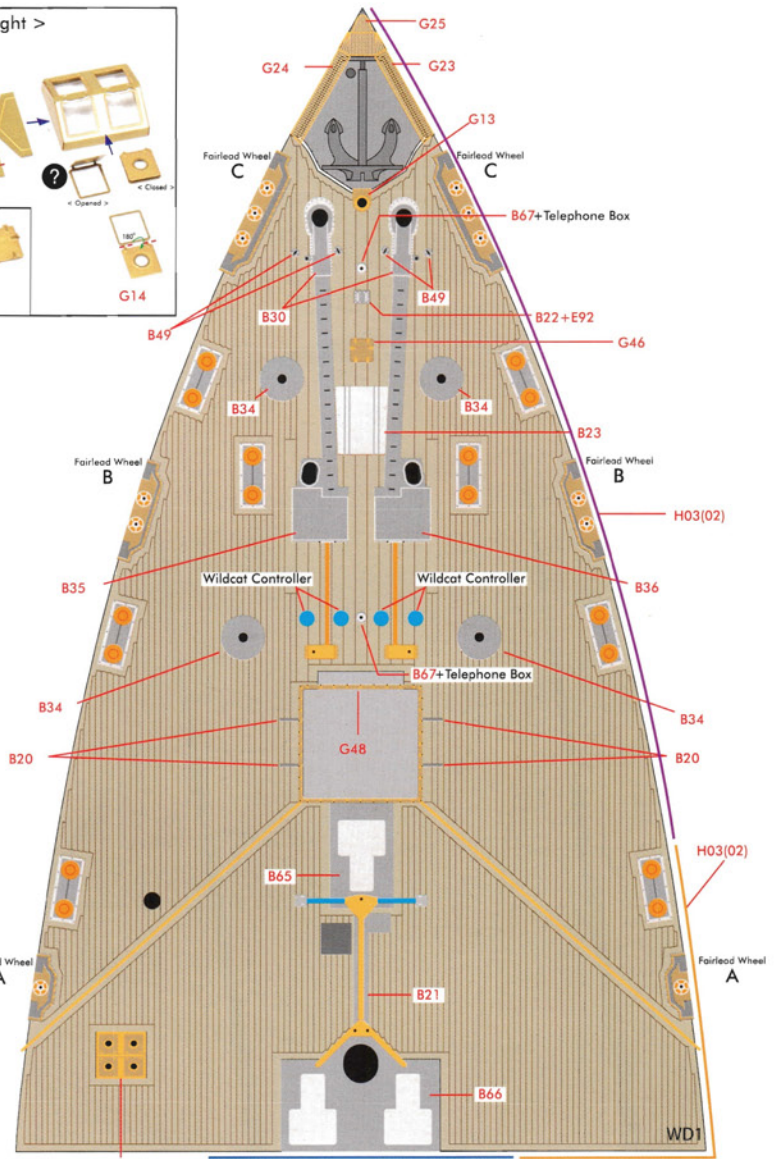
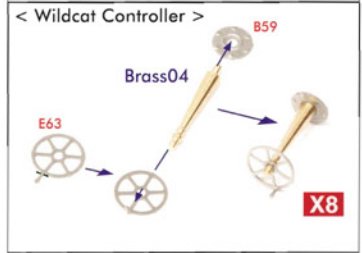
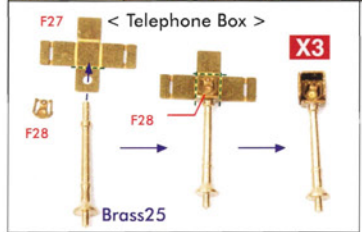
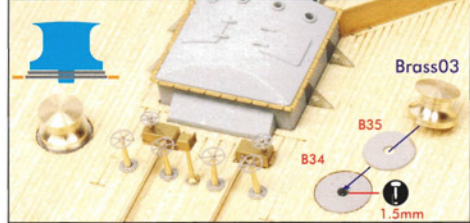
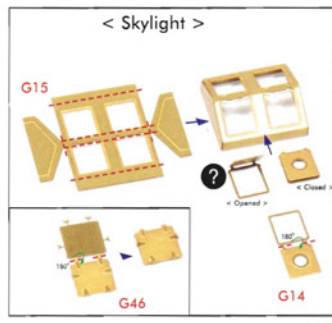
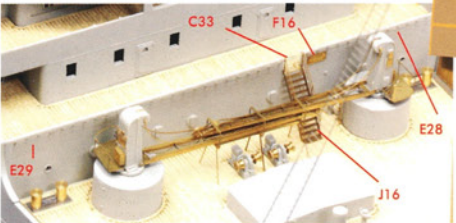

< Fairlead Wheel >

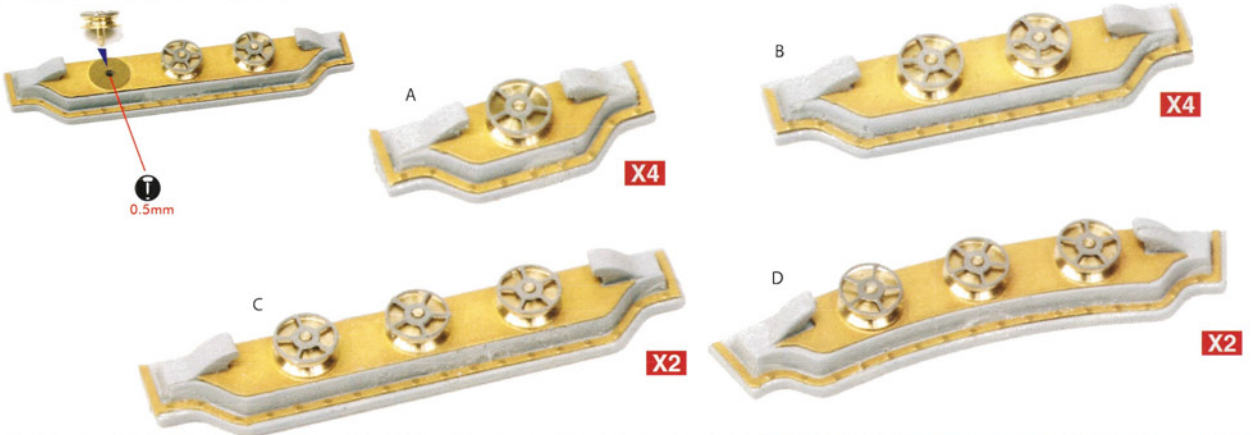
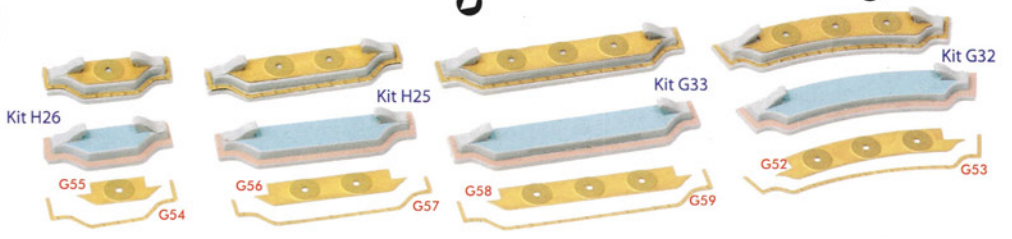
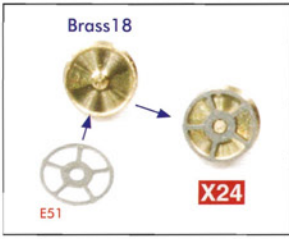
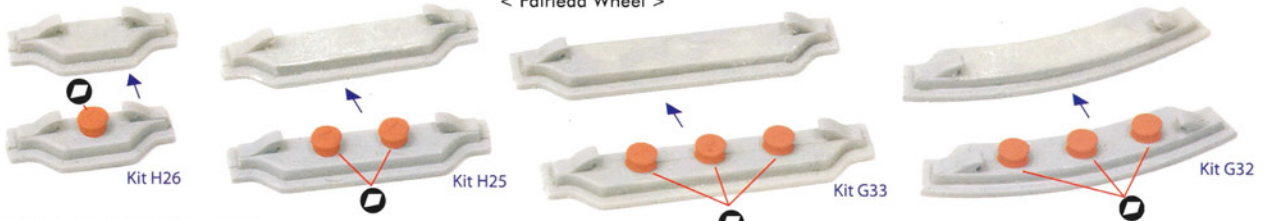

< Bollard >

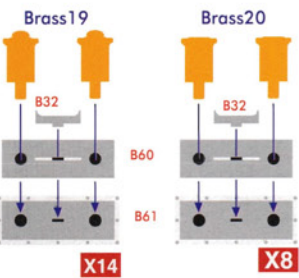

< Welldeck Bollard >

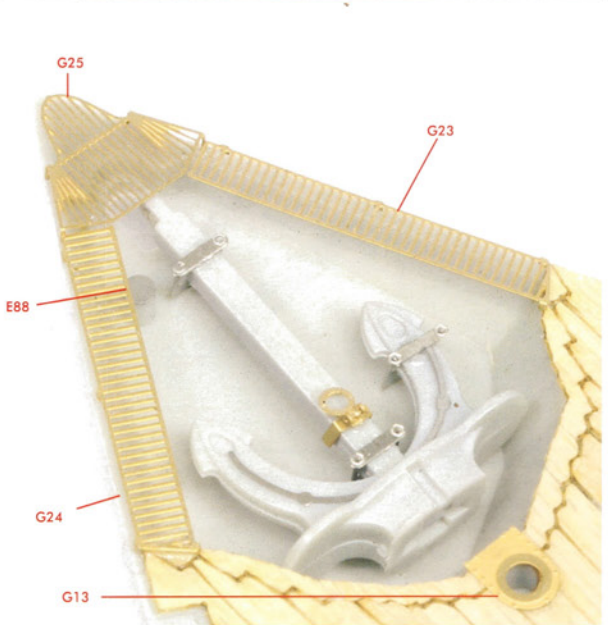
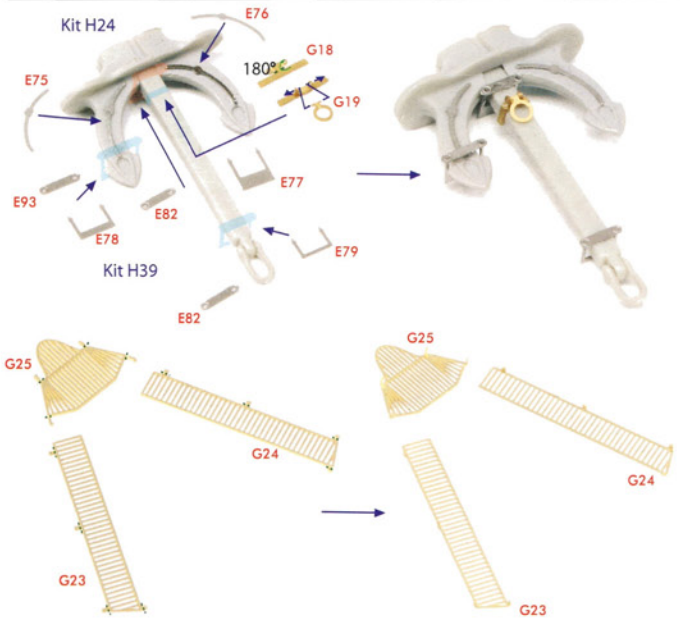
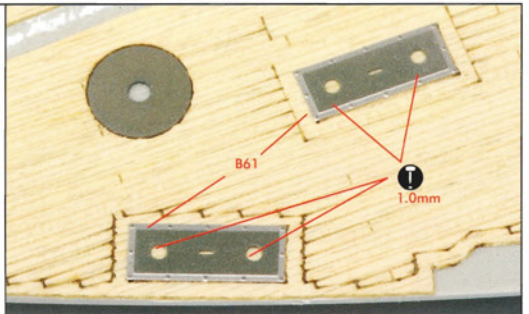
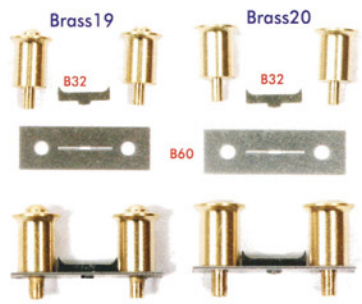

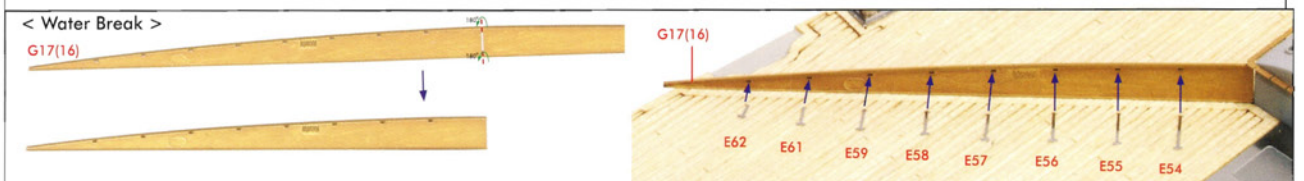
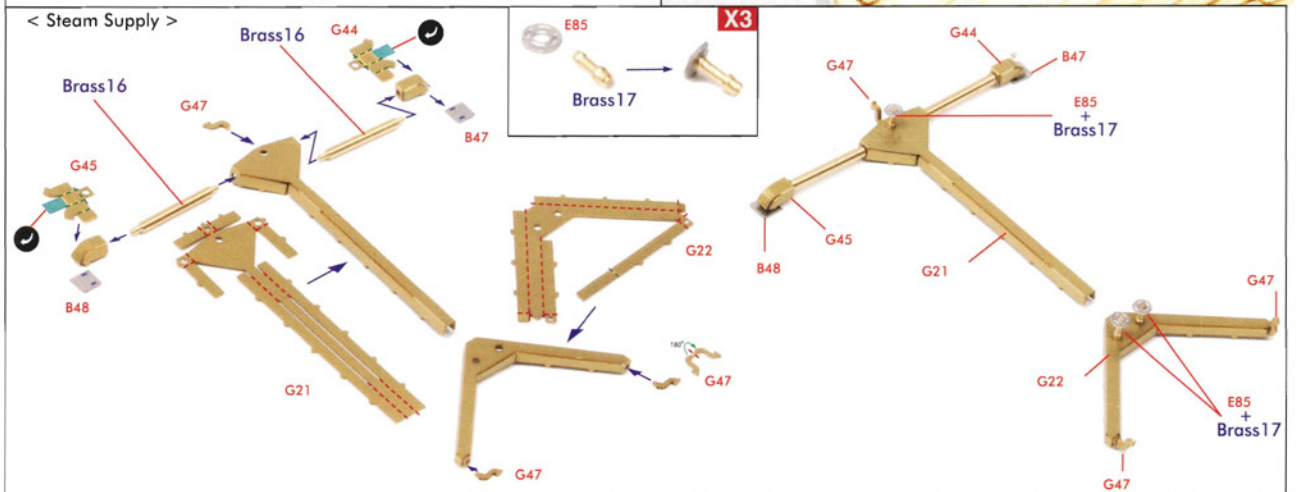
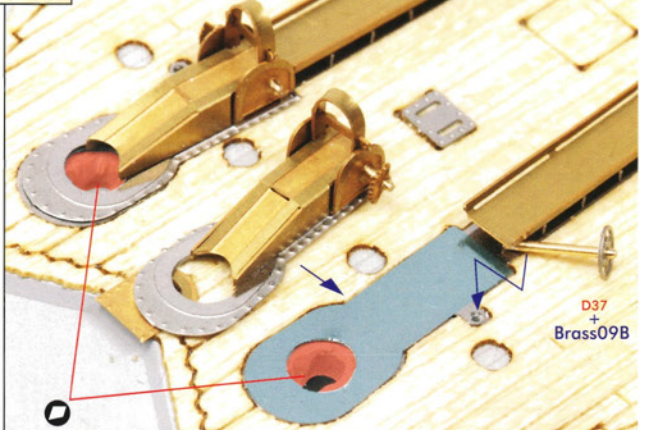
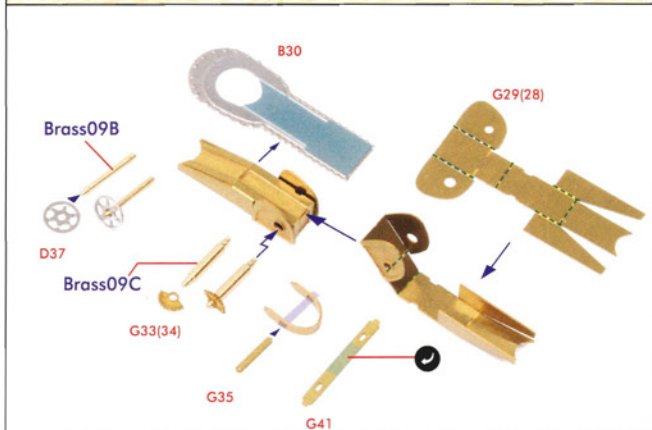
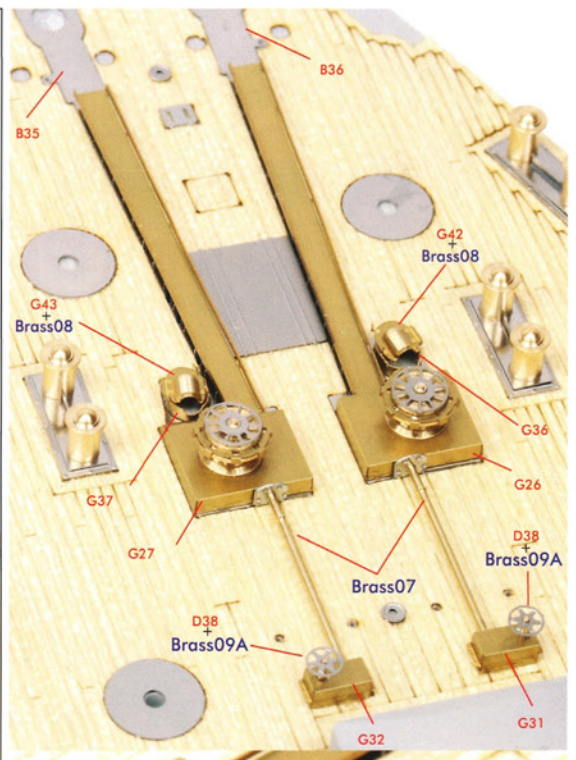
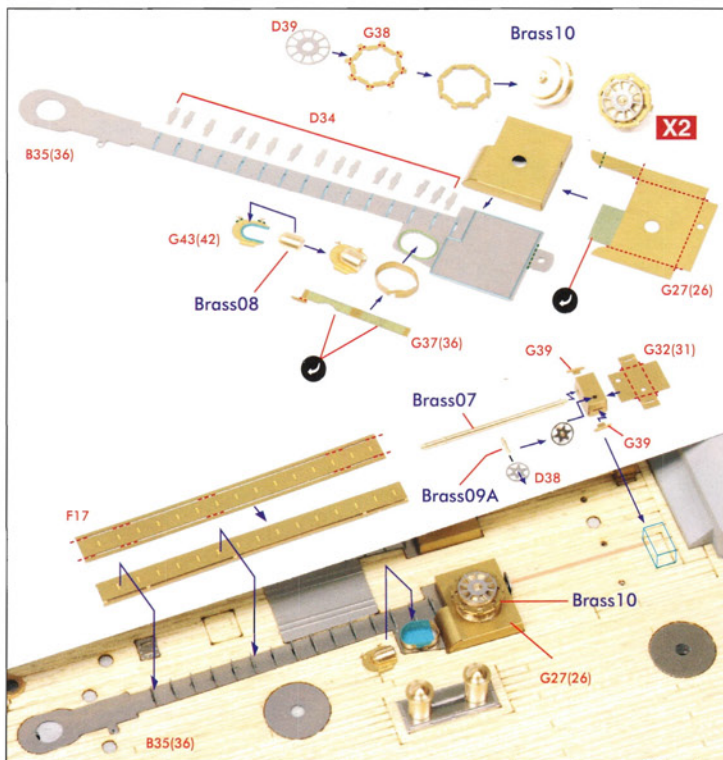

< Anchor Crane >

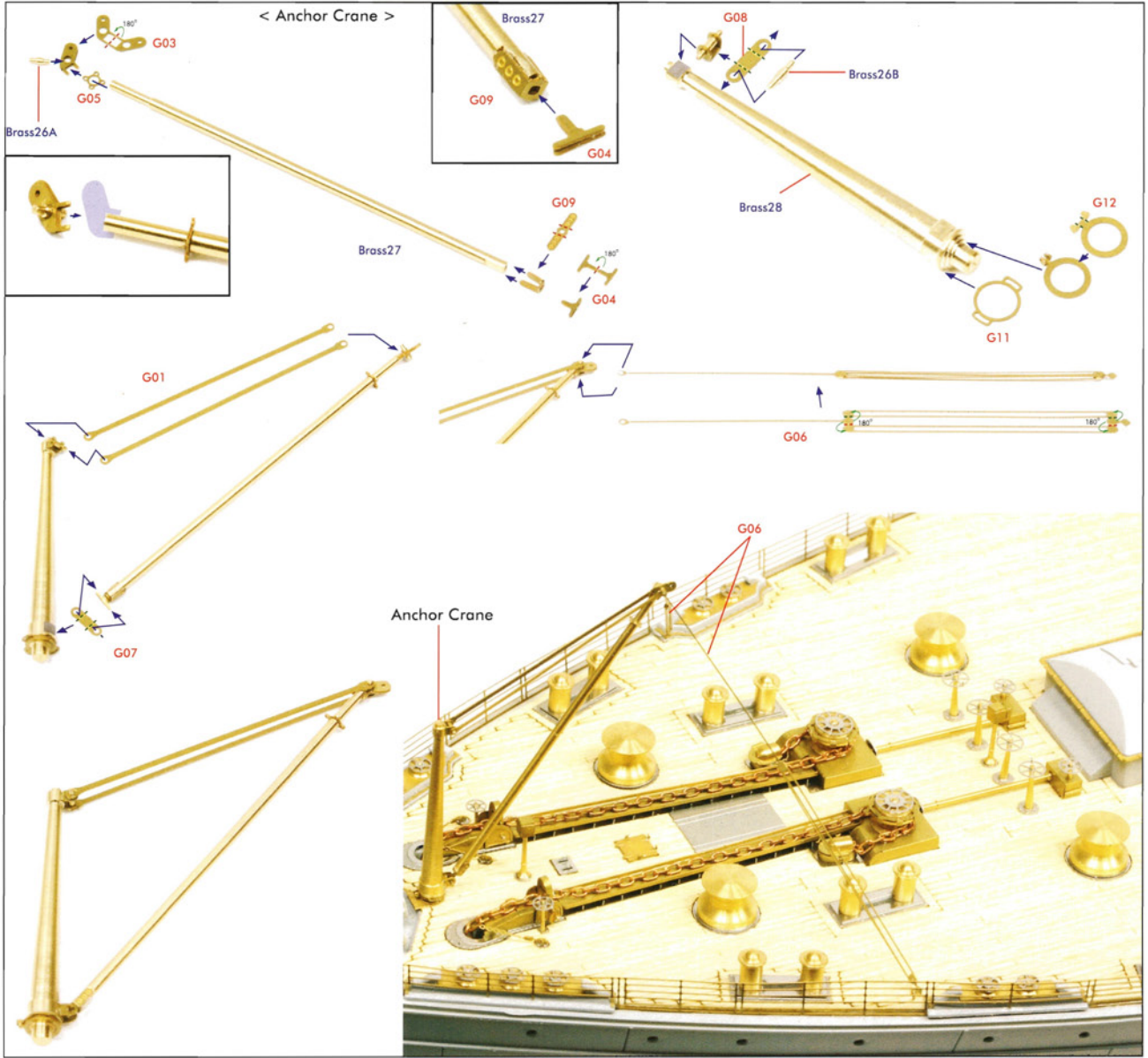

< Winch >

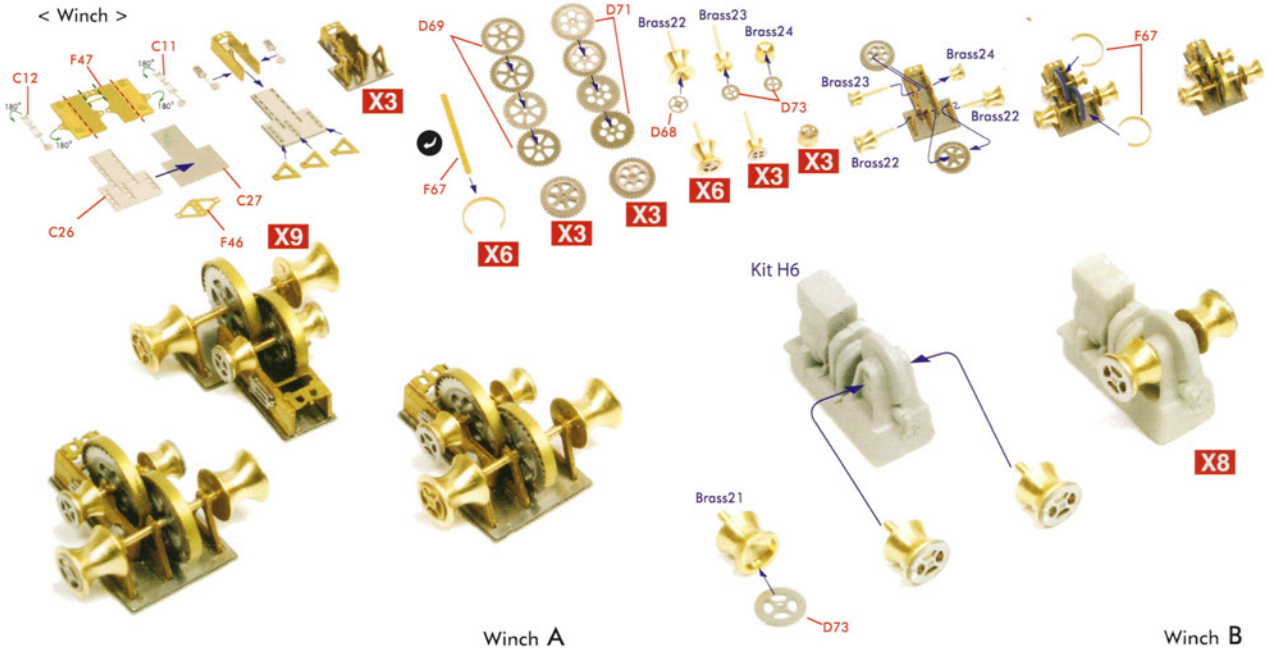

Winch A

Winch B

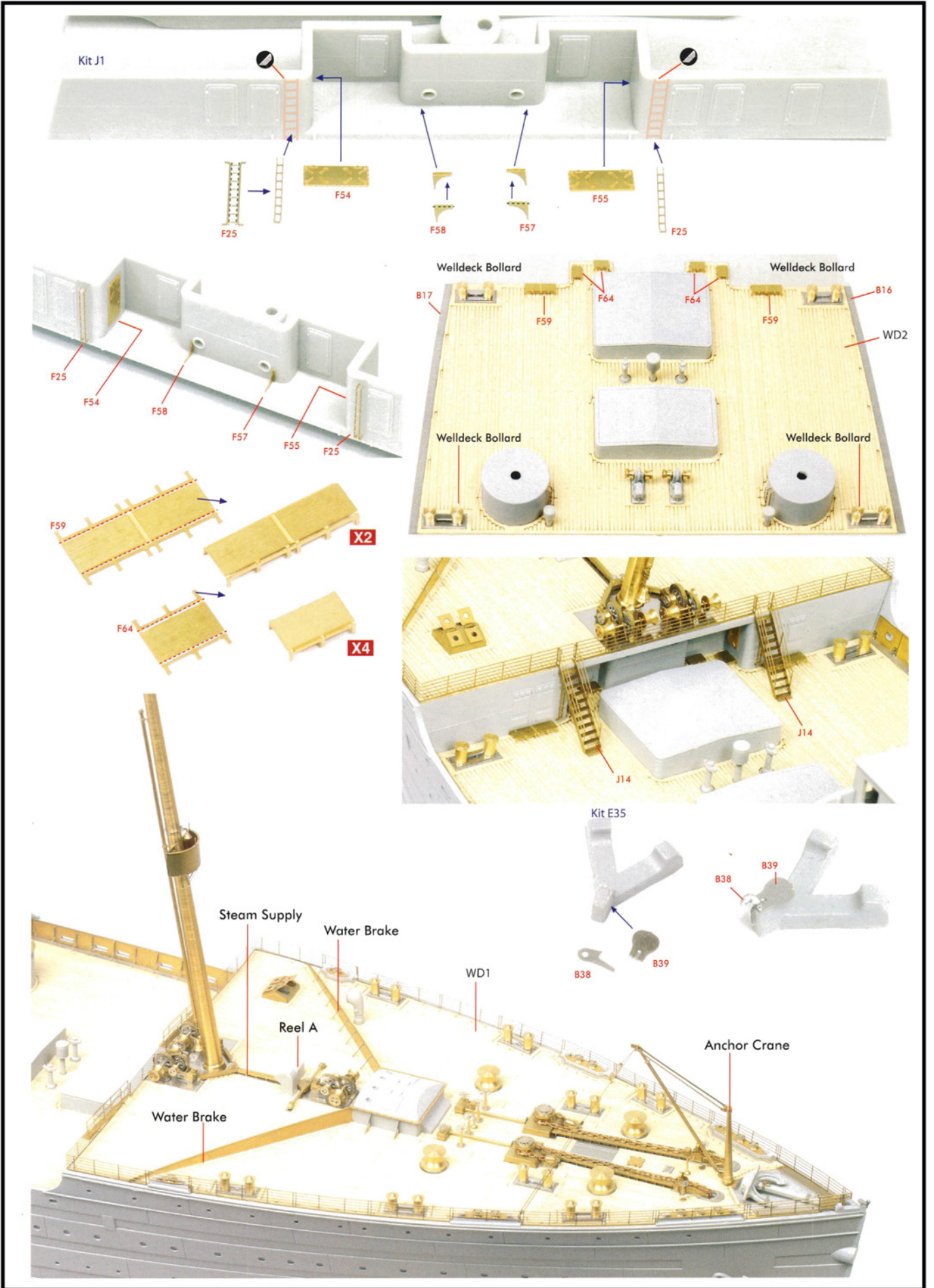

Kit J1

F25

F54

F58

F57

F55

F25

Welldeck Bollard

Welldeck Bollard

B17

B16

F59

F64

F64

F59

WD2

Welldeck Bollard

Welldeck Bollard

F25

F54

F58

F57

F55

F25

F59

X2

F64

X4

Kit E35

B38

B39

Steam Supply

Water Brake

WD1

Reel A

Anchor Crane

Water Brake

< Reel >

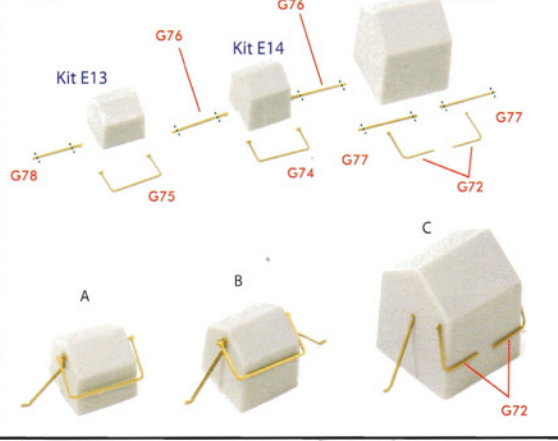

Fore, After Mast

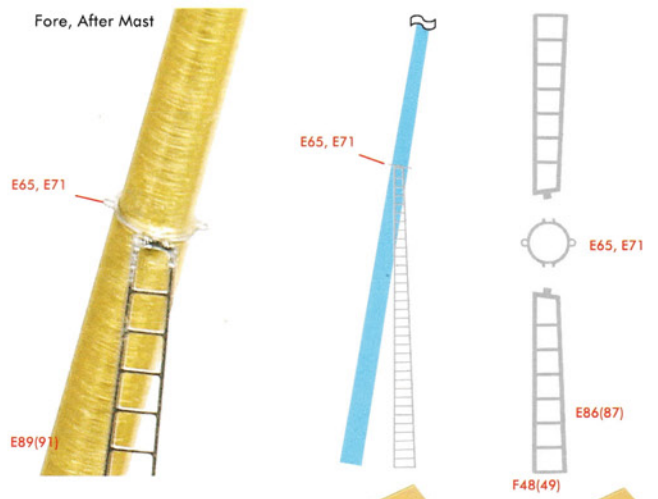

< Forward Welldeck Bulwark >

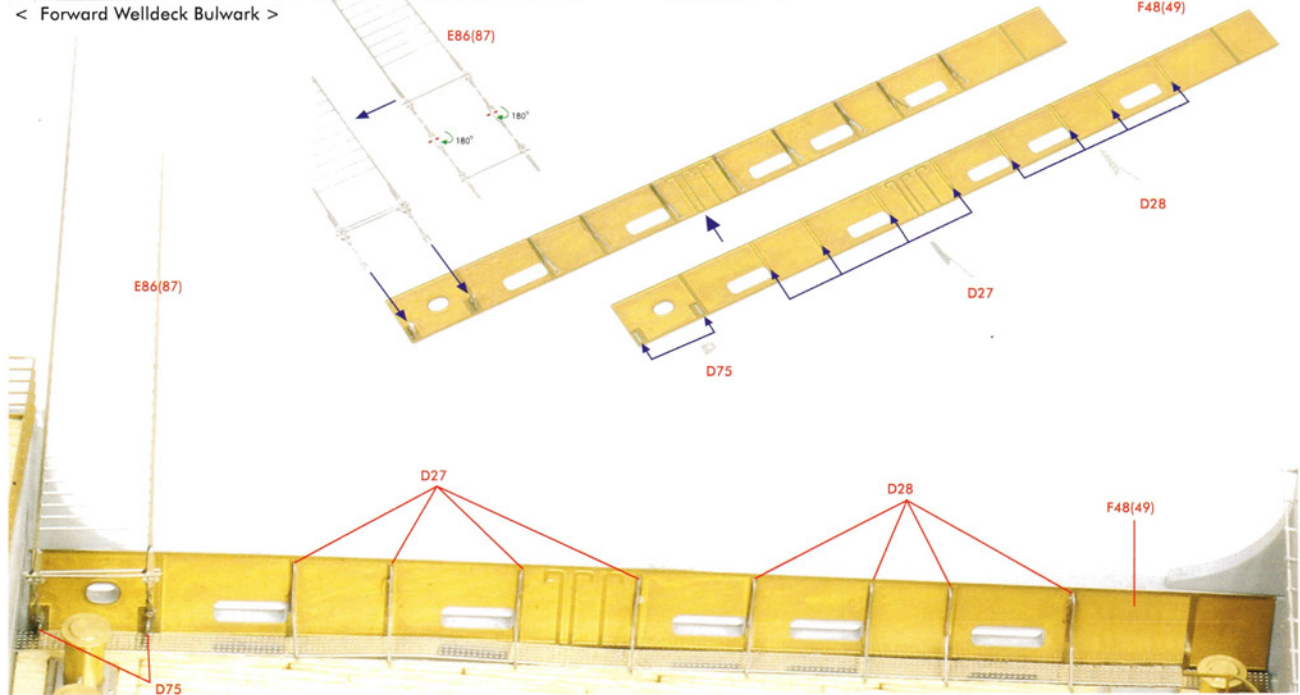

< After Welldeck Bulwark >

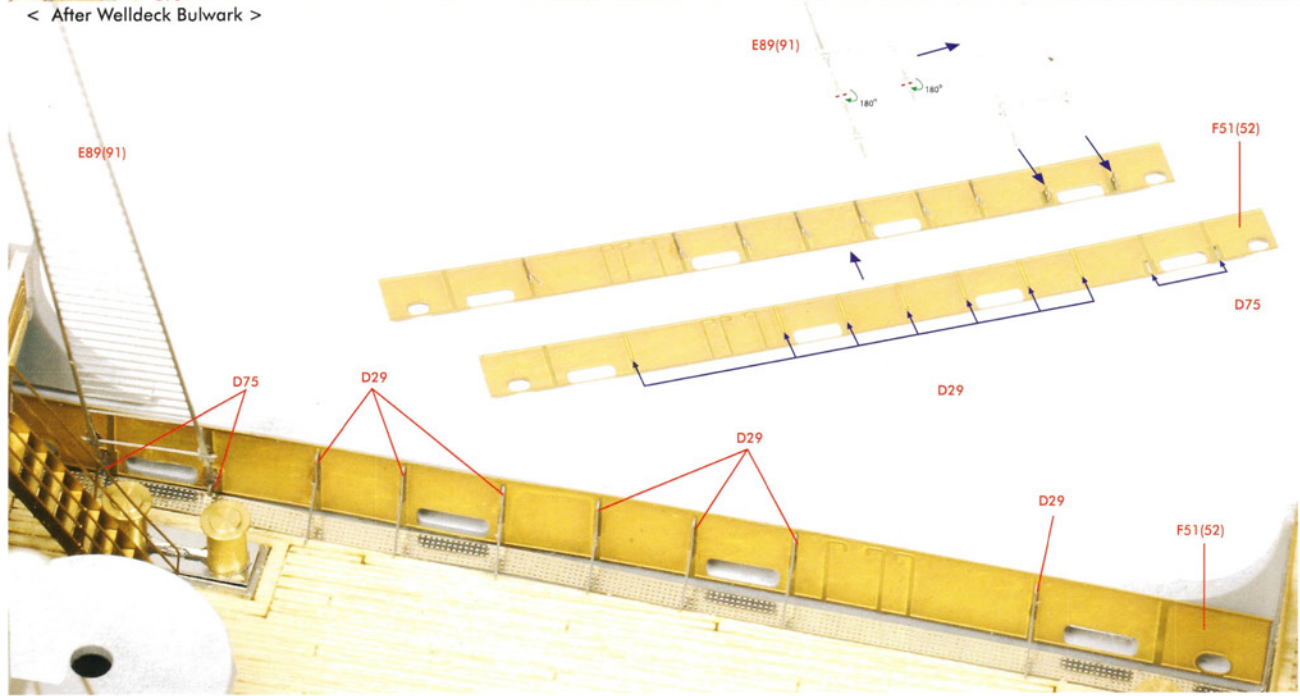

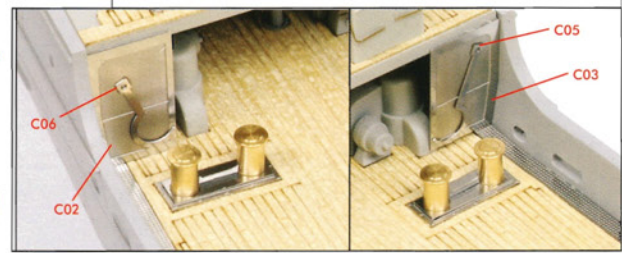
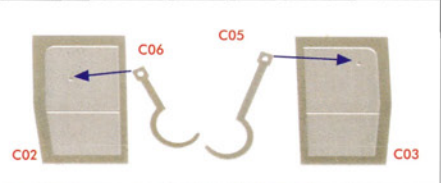
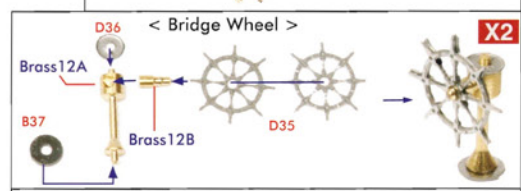
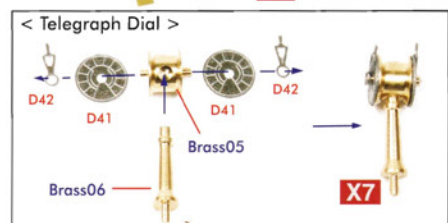
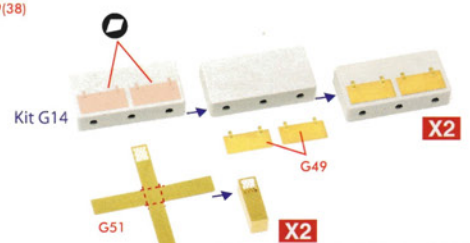
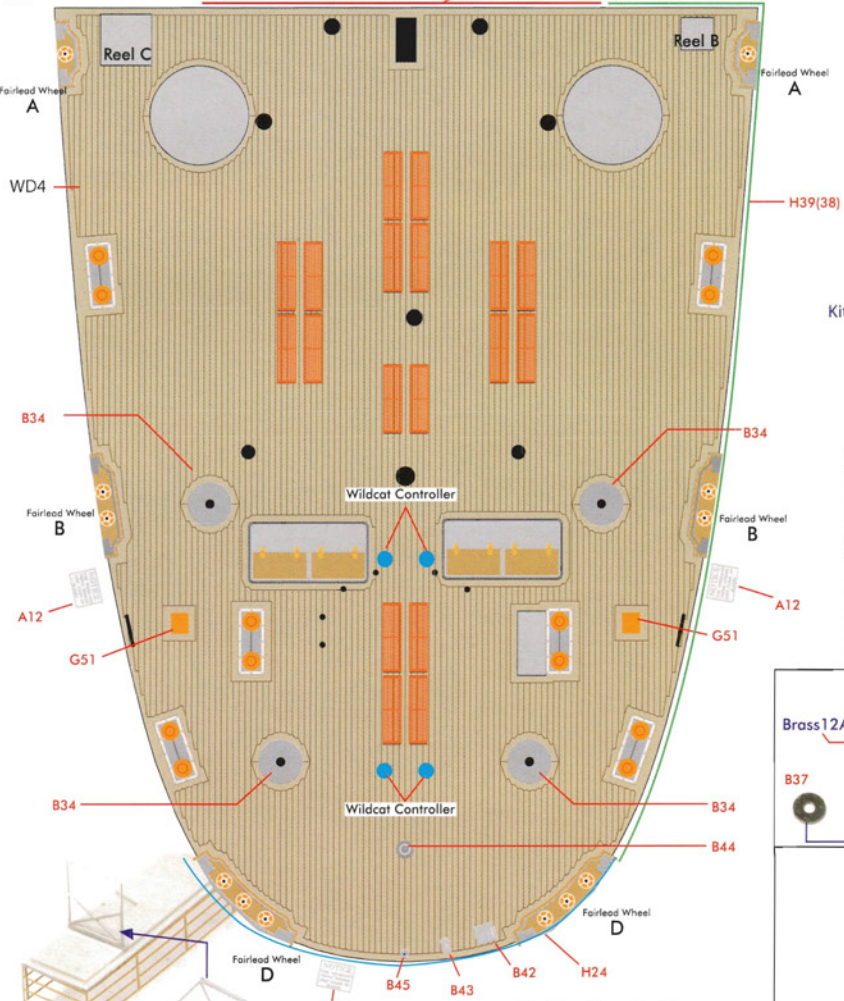
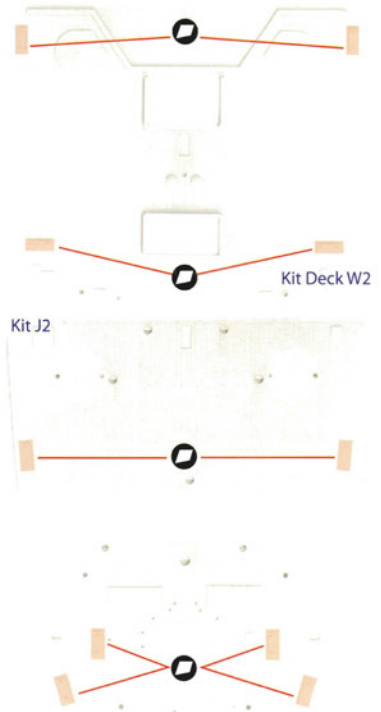
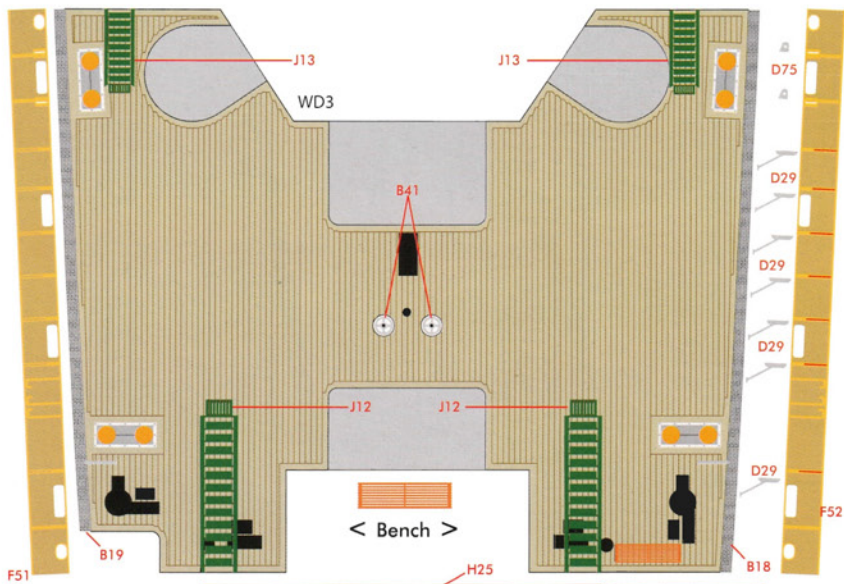

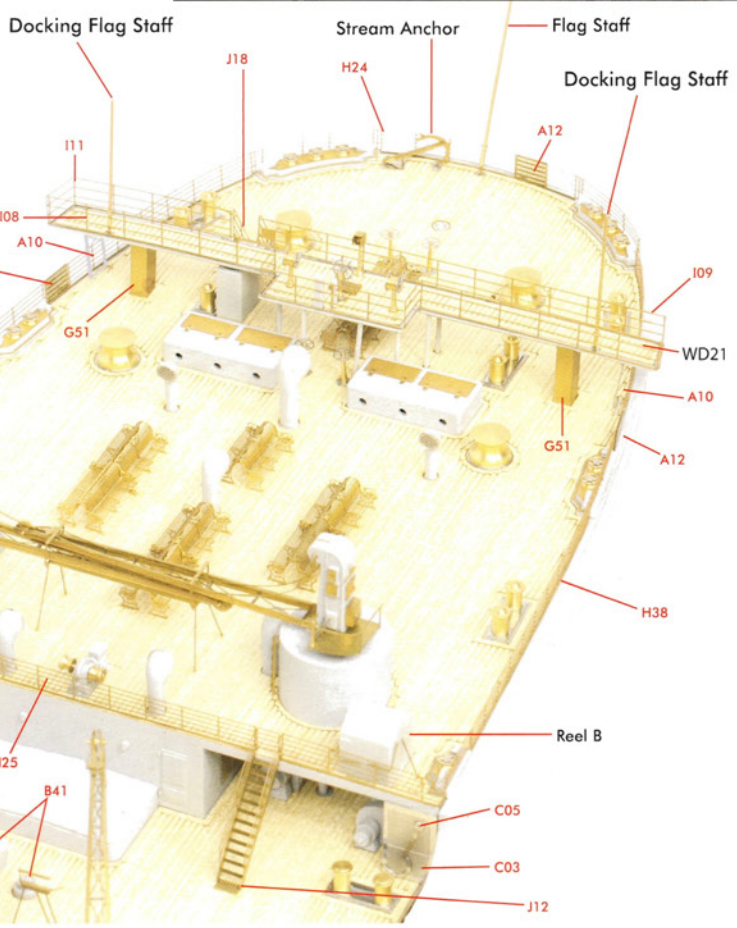
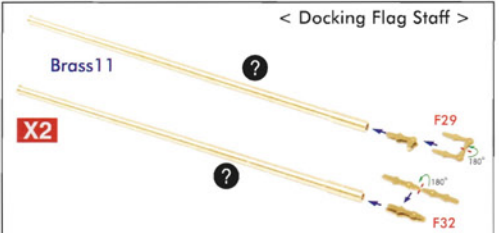
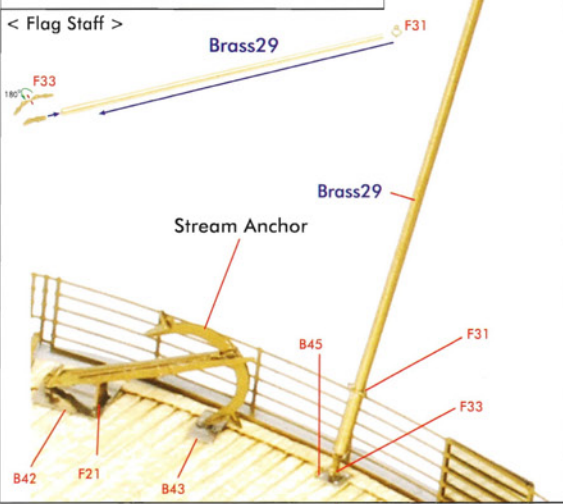
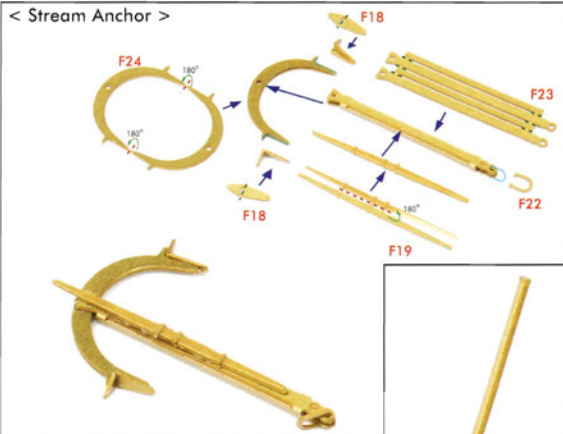
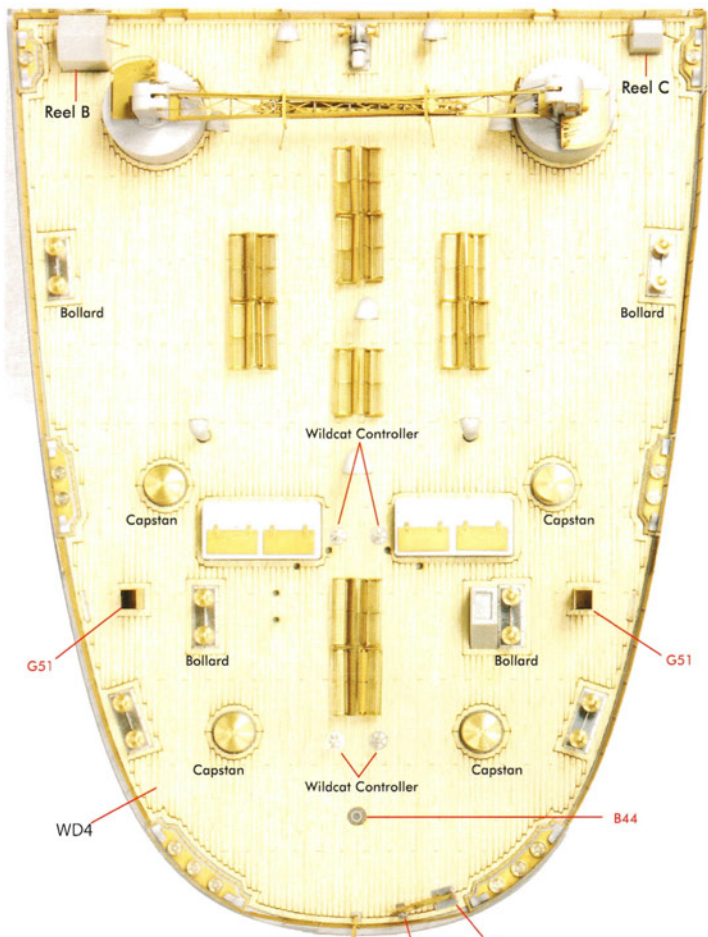

< Window Frames >

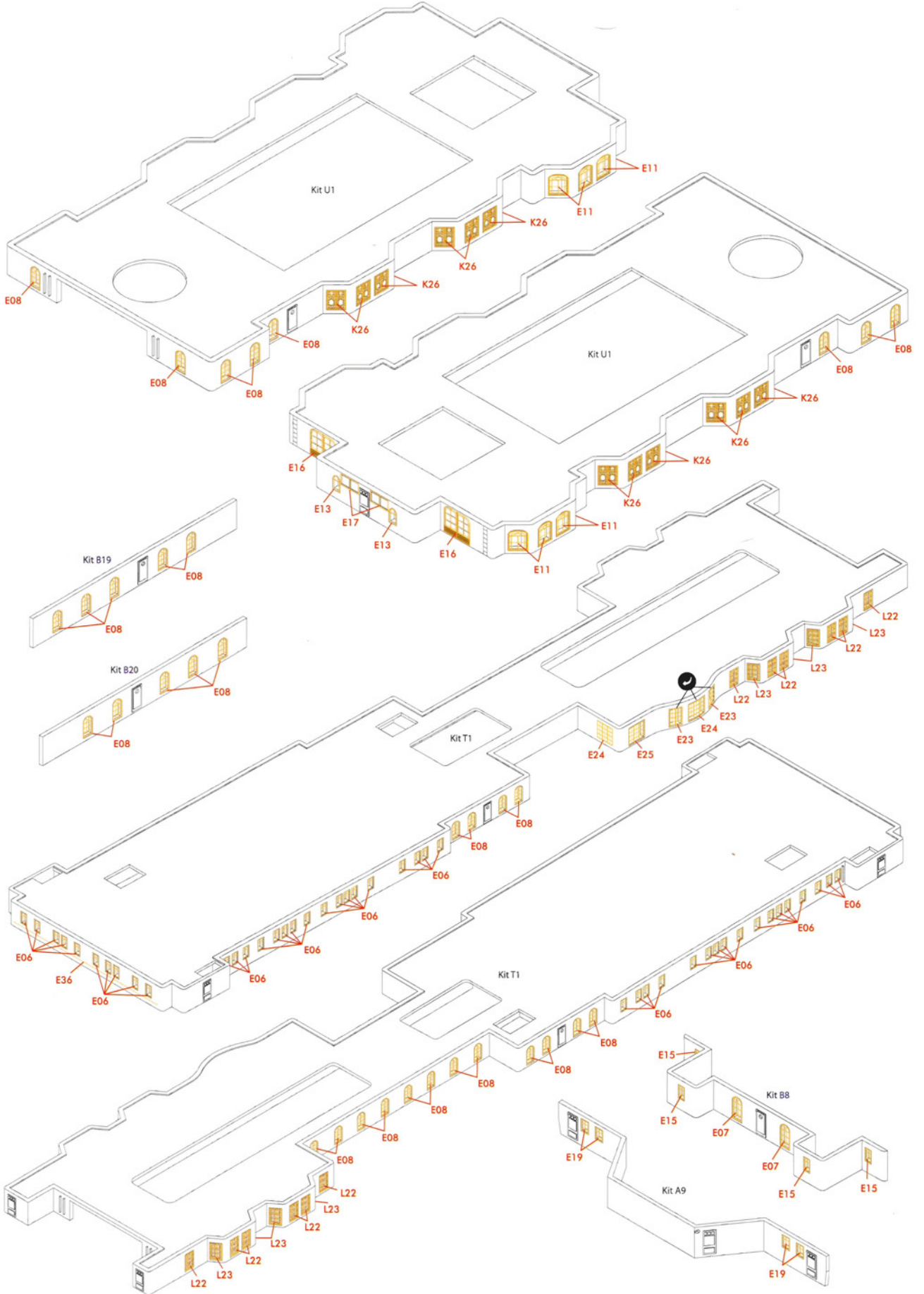

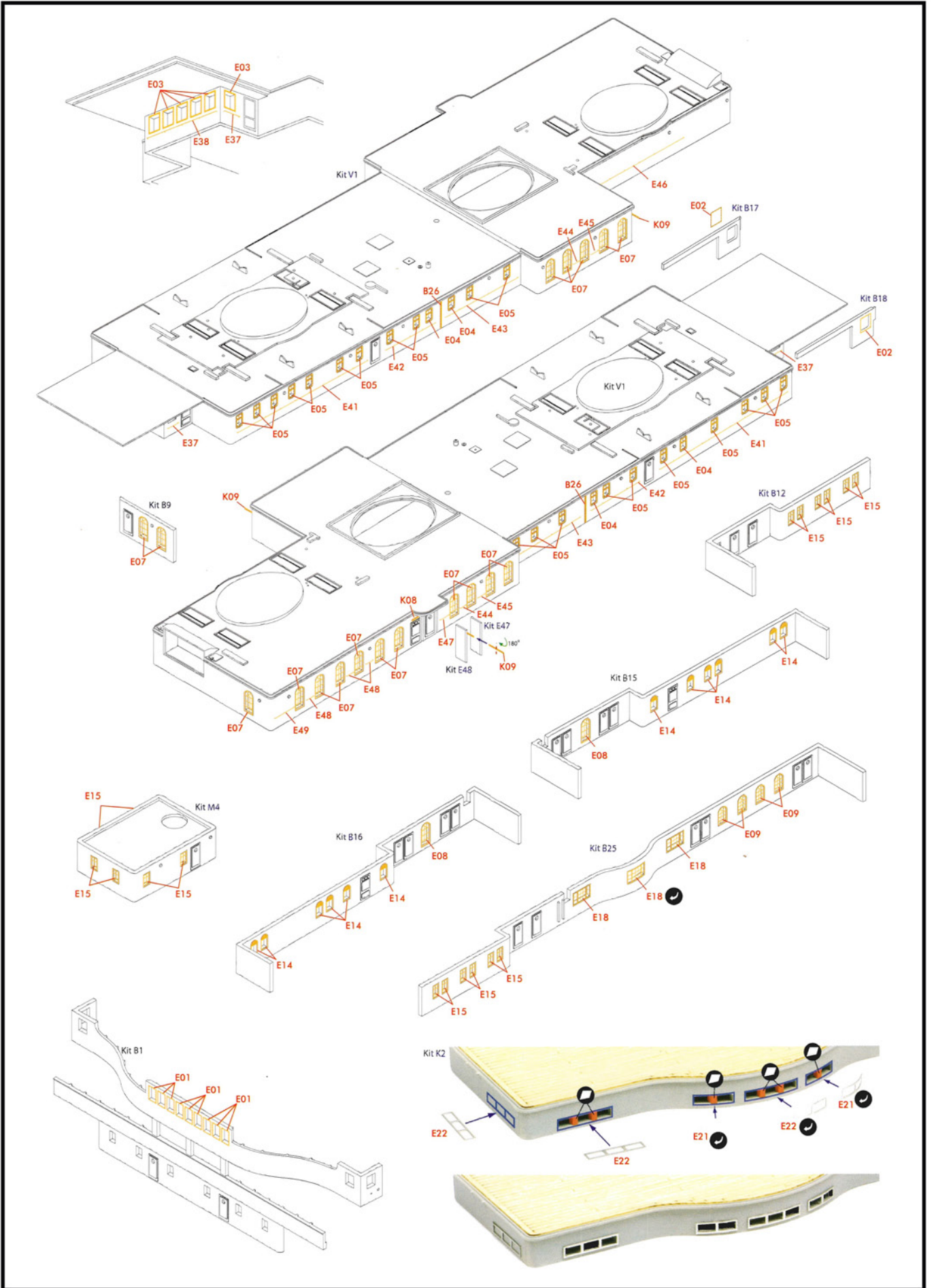

Boat Deck

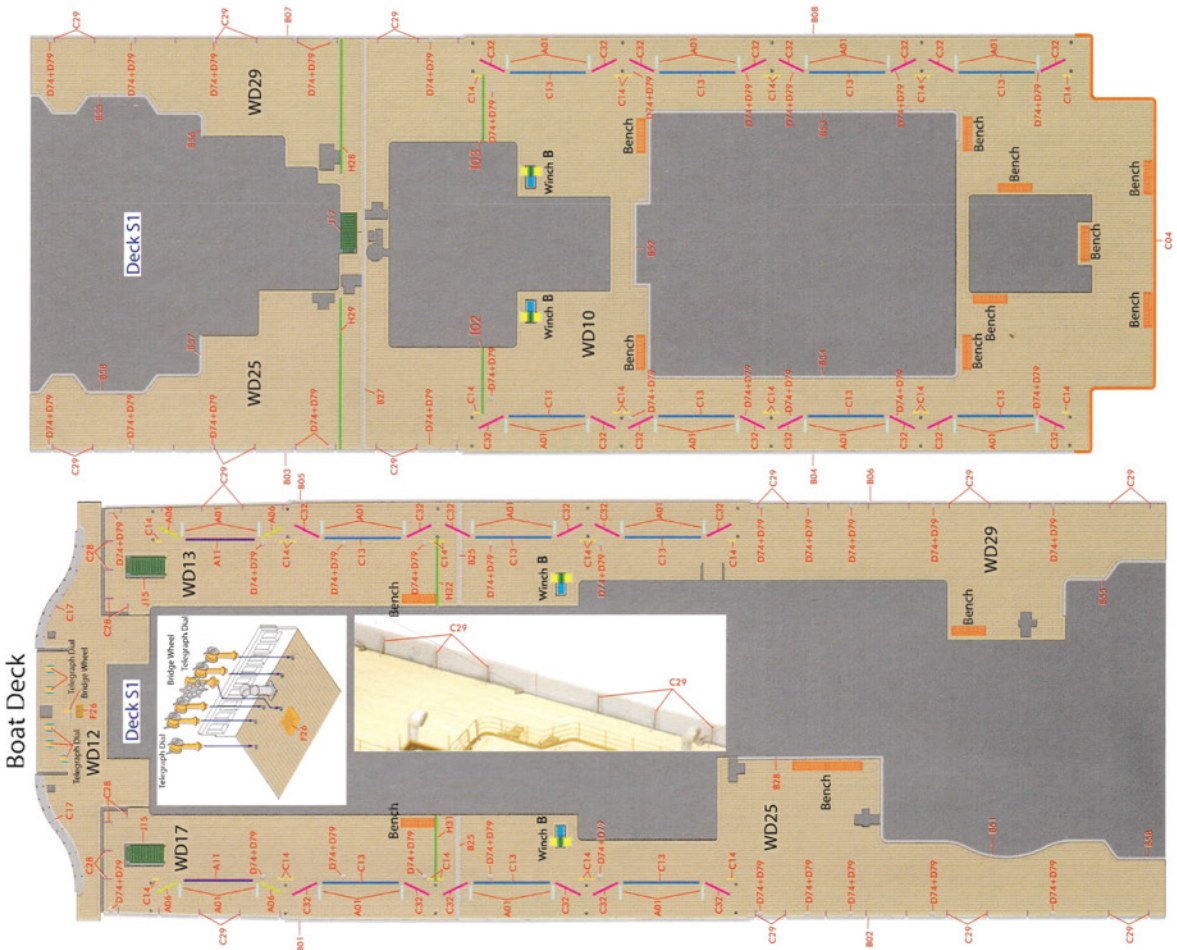

A Deck

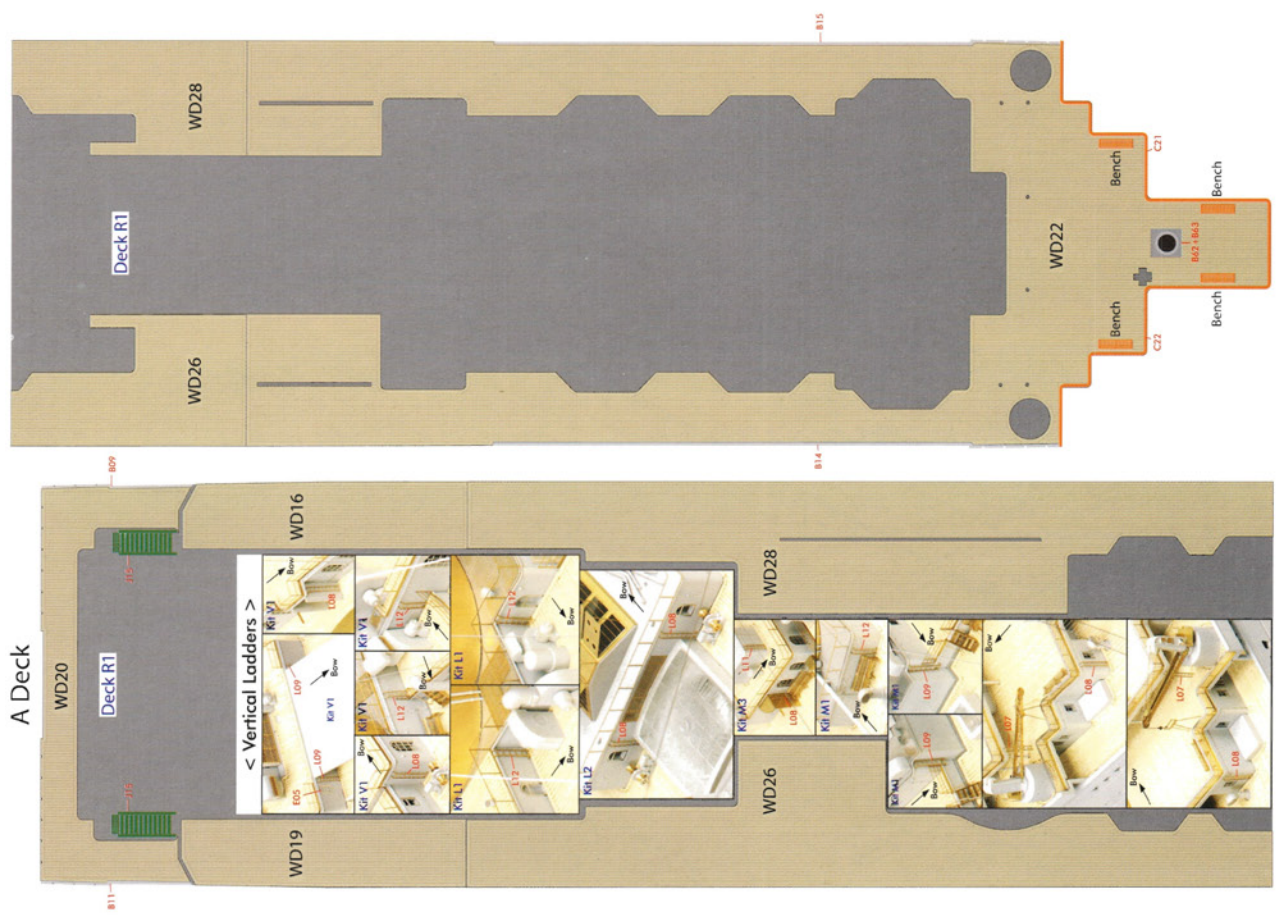

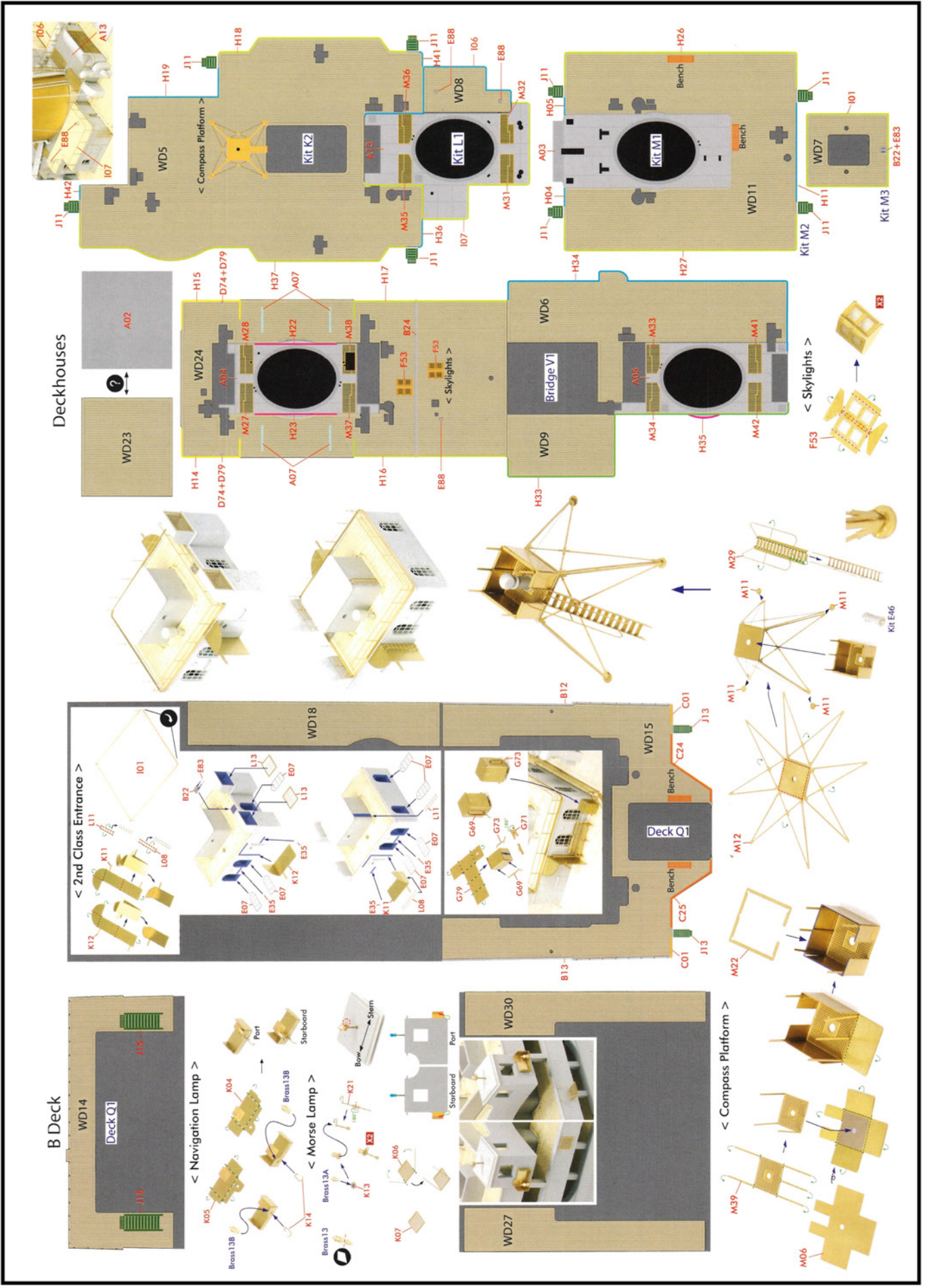

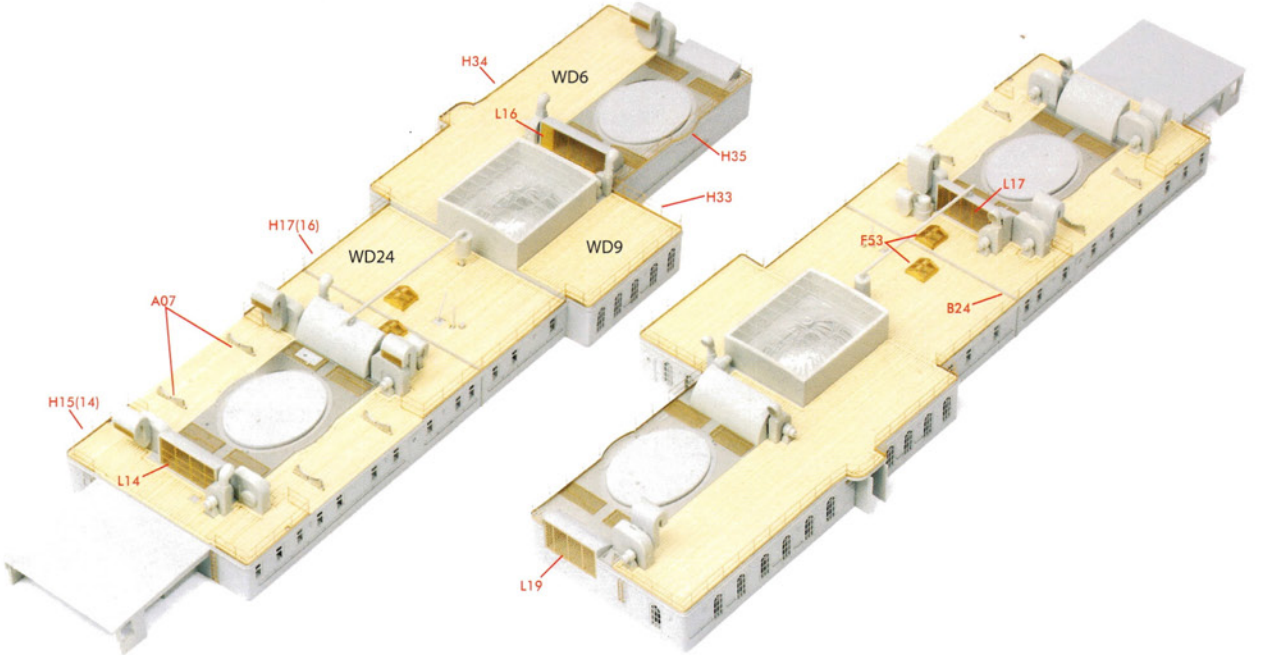
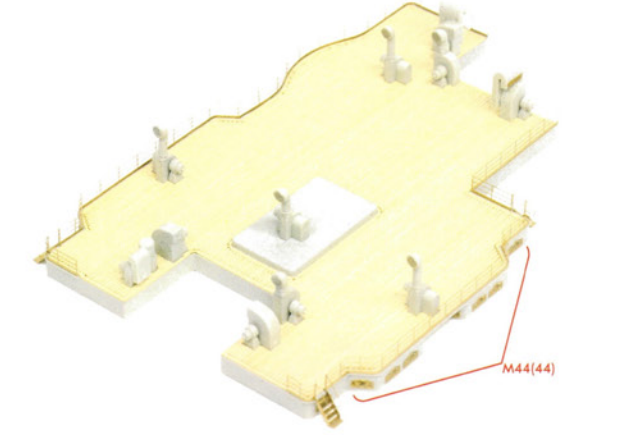
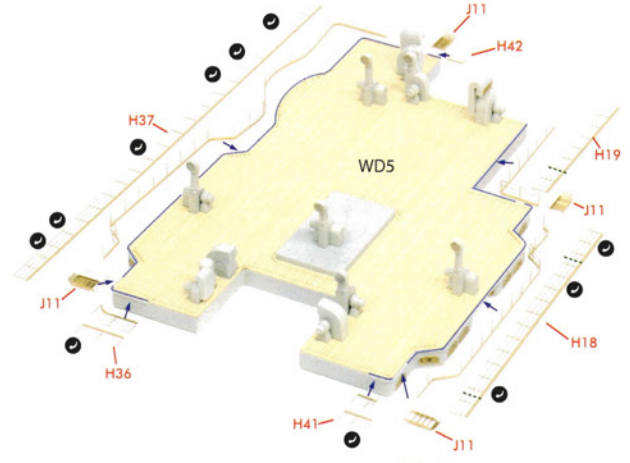
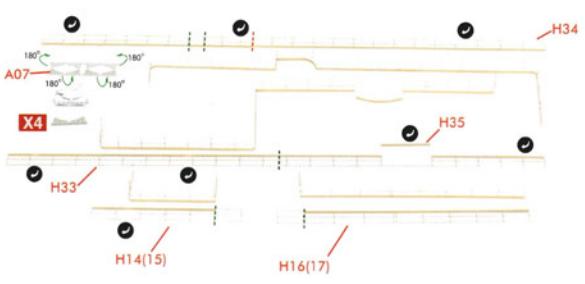
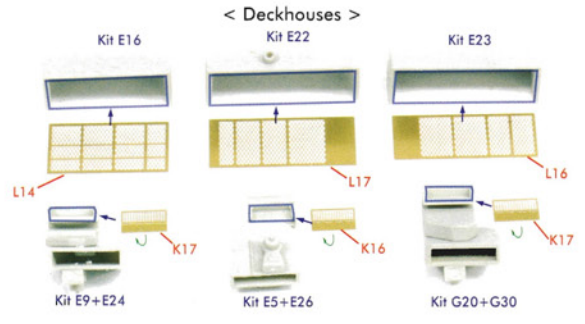
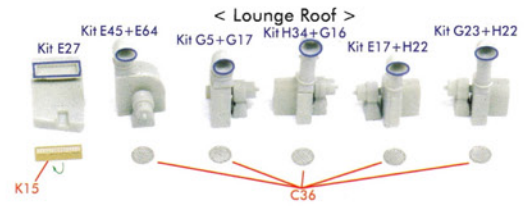
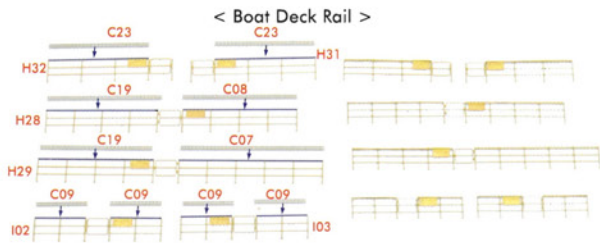

< No.3 Funnel Deckhouse >

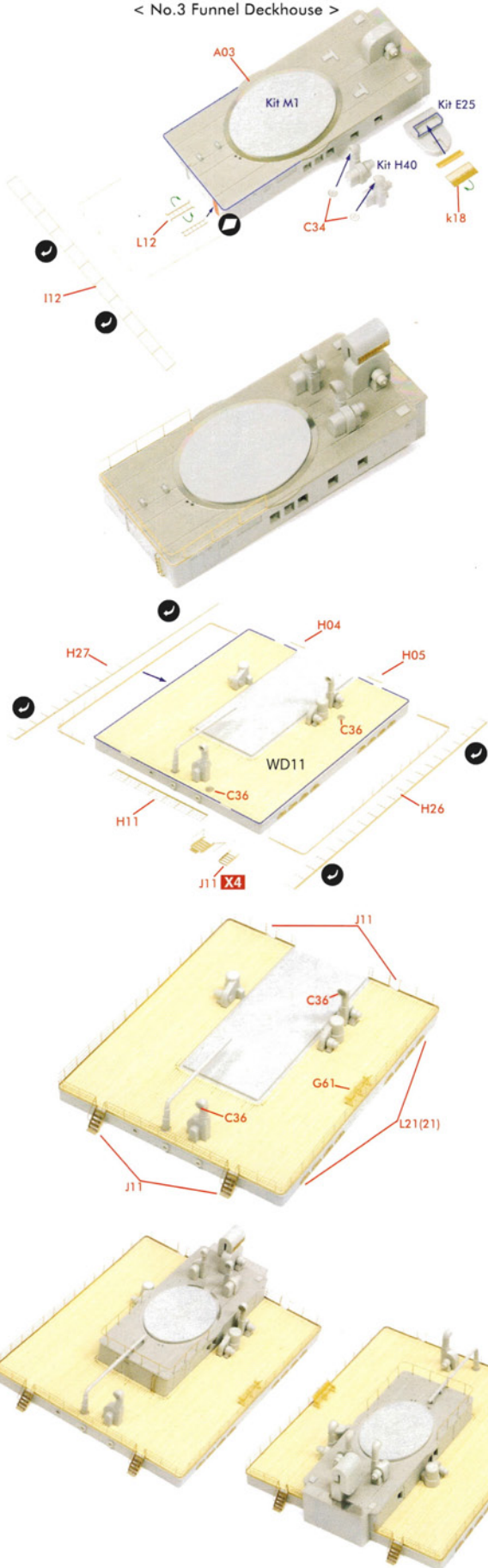

< Teak Rail >

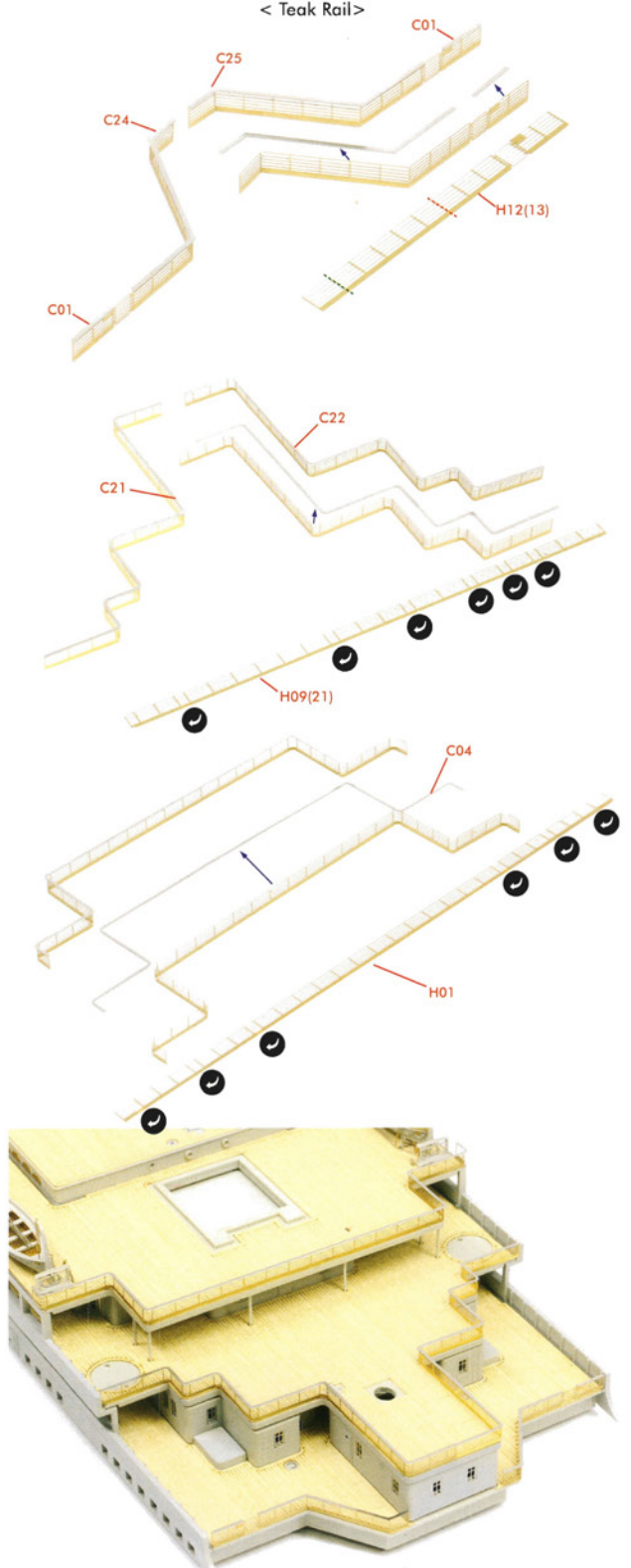

< Stairs >

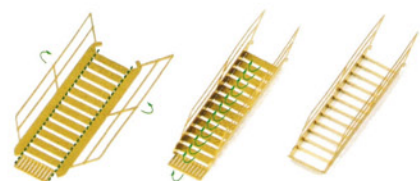

- H11 X8
- H12 X2
- H13 X2
- H14 X2
- H15 X4
- H16
- H17
- H18

< Funnel >

Remove all rivets

Kit C2

Kit C1

Kit X1

Kit X1



Funnel 1



Funnel 2



Funnel 3



Funnel 4

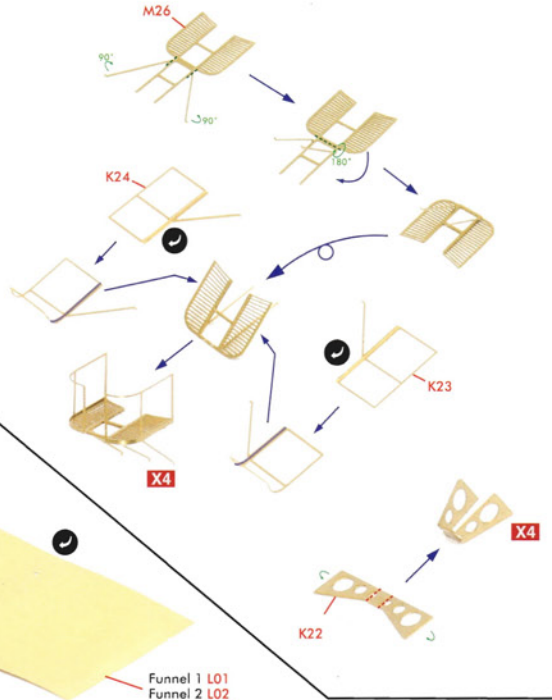

Funnel 1 C2
Funnel 2 C1
Funnel 3 X1
Funnel 4 X1

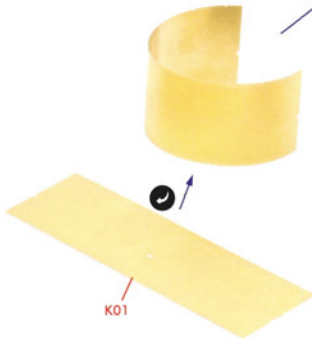

K01

Bow

Funnel 1 L01
Funnel 2 L02
Funnel 3 M01
Funnel 4 M02

Funnel 4

Funnel 1 L03
Funnel 2 L04
Funnel 3 L05
Funnel 4 L06

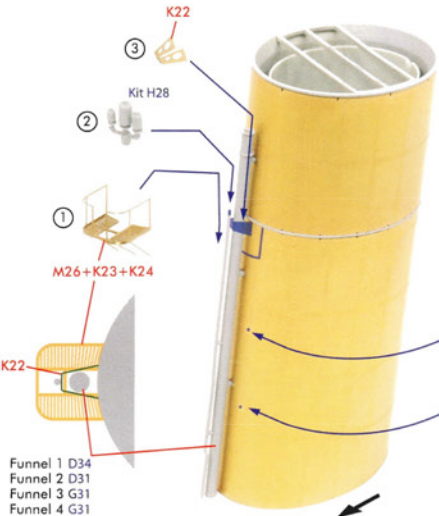

K22

Kit H28

M26+K23+K24

K22

Funnel 1 D34
Funnel 2 D31
Funnel 3 G31
Funnel 4 G31

Bow

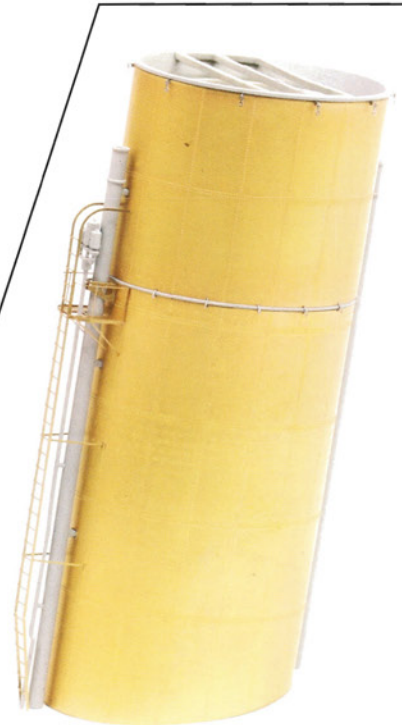
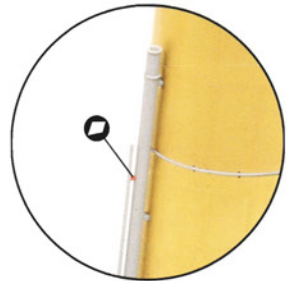
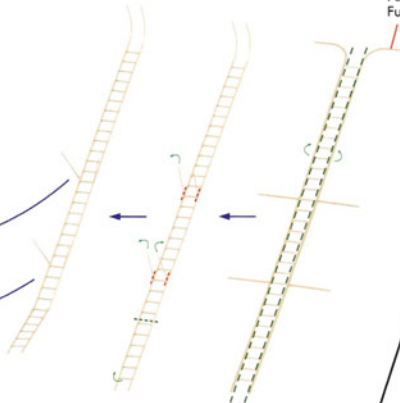

Make other funnels same way.

< Painter's Line Block >

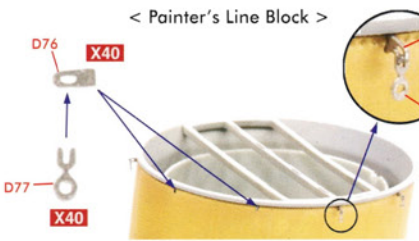

D76

X40

D76

D77

D77

X40

< Guy Wire Funnel Bracket >

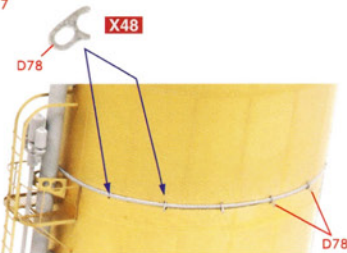

D78

X48

D78

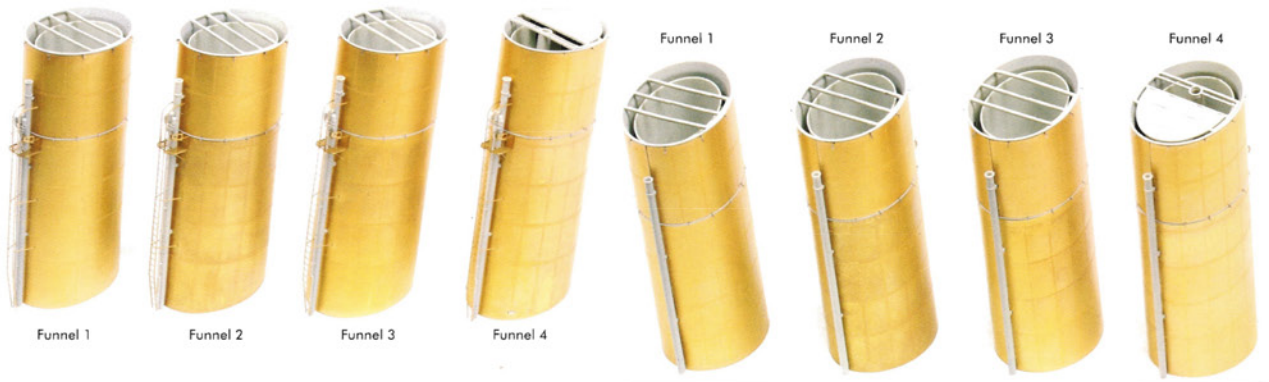

Funnel 1

Funnel 2

Funnel 3

Funnel 4

Funnel 1

Funnel 2

Funnel 3

Funnel 4

< Guy Wire >

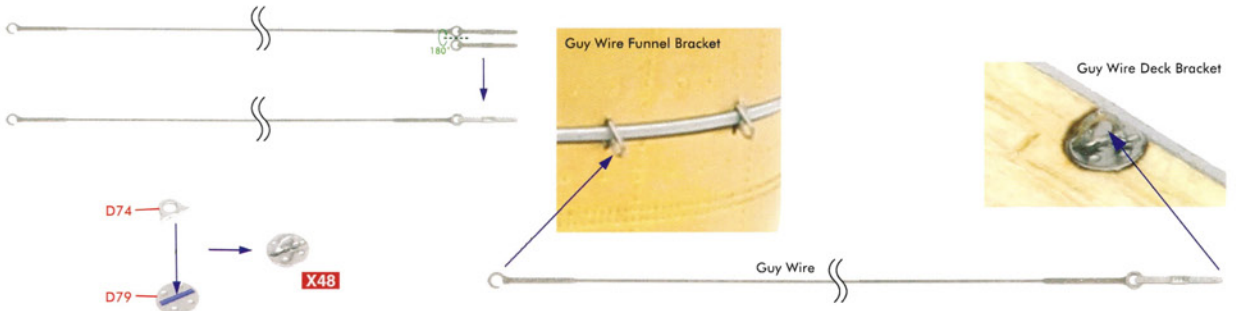

Funnel 1

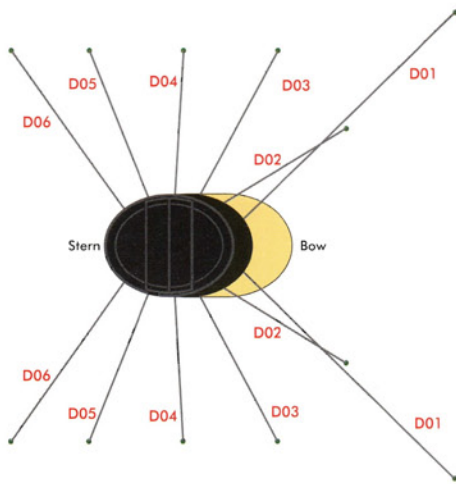

Funnel 2

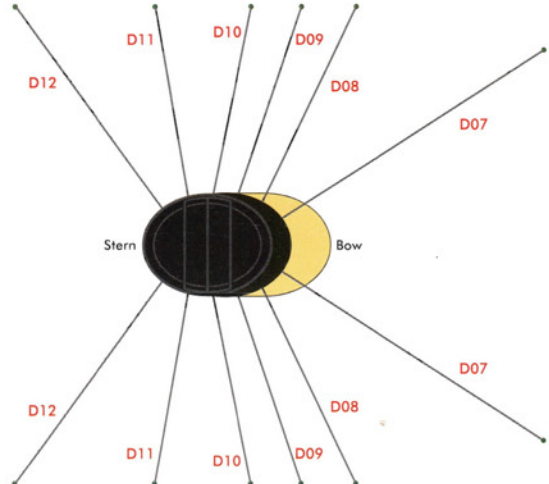

Funnel 3

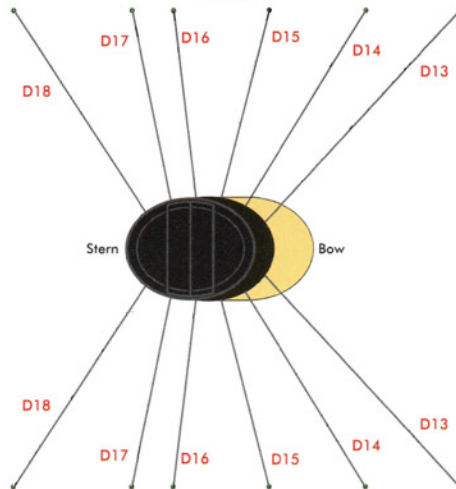

Funnel 4

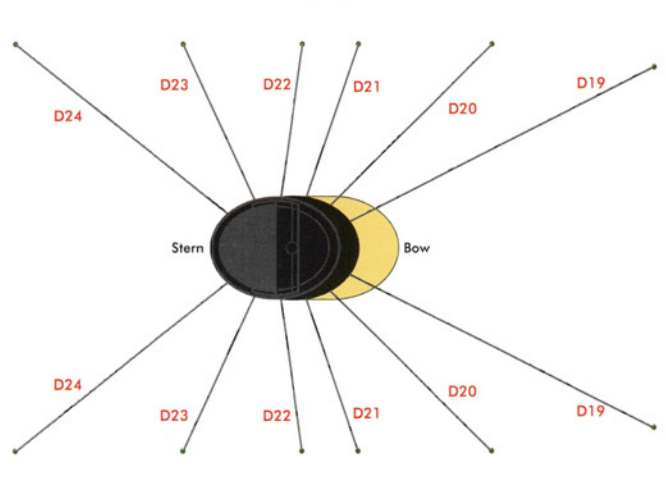

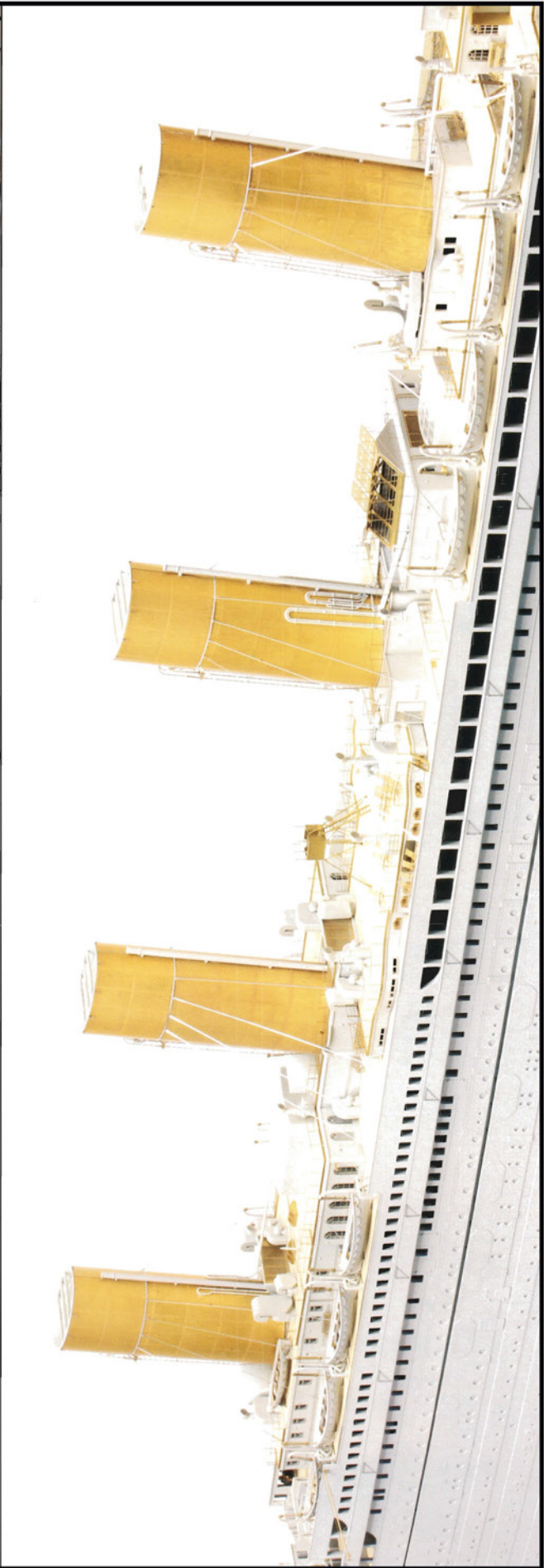
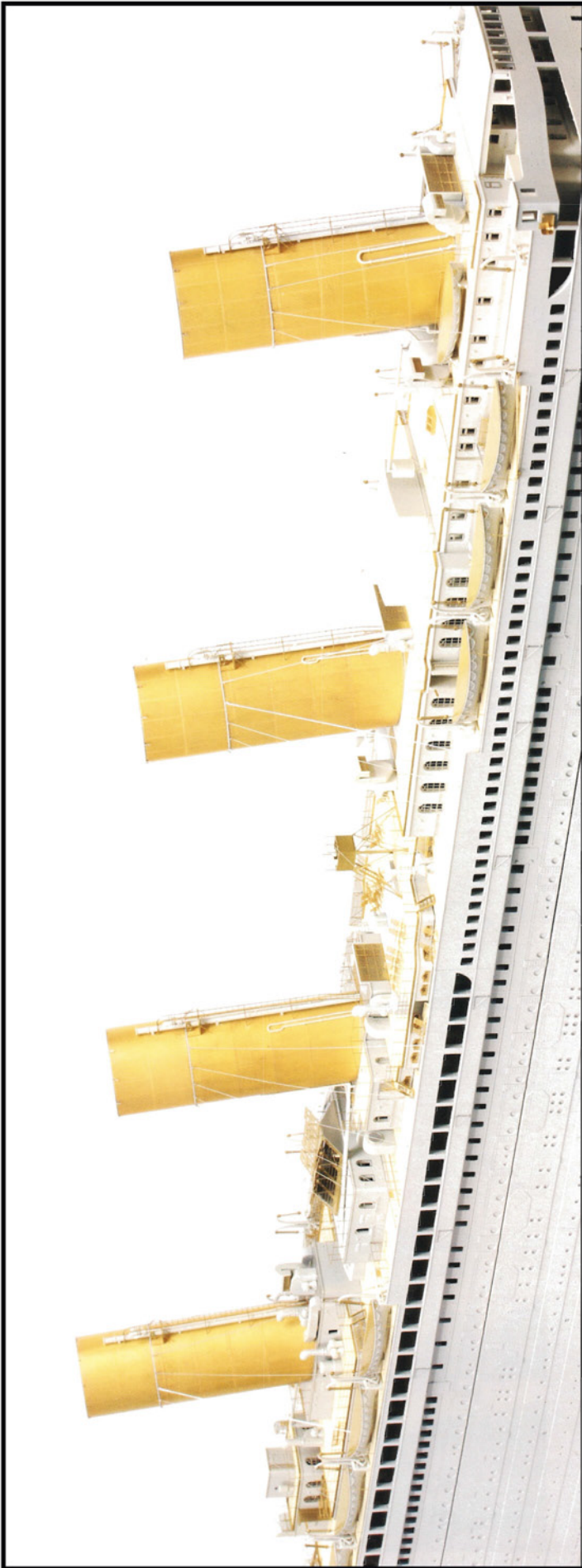

< Boat >

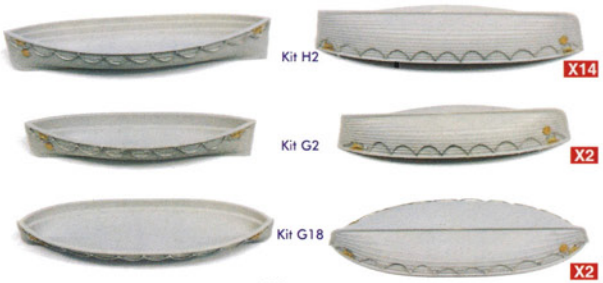
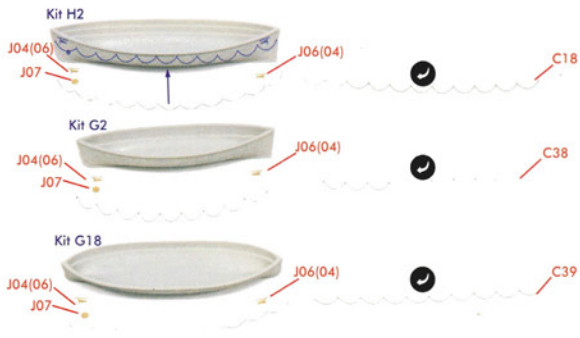

< 30ft Boats >

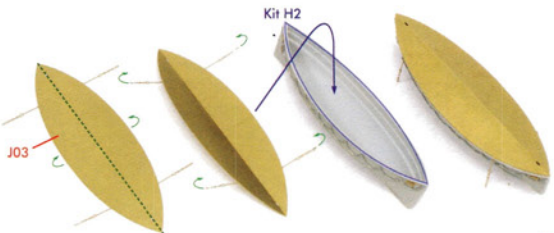

X14
?
X14

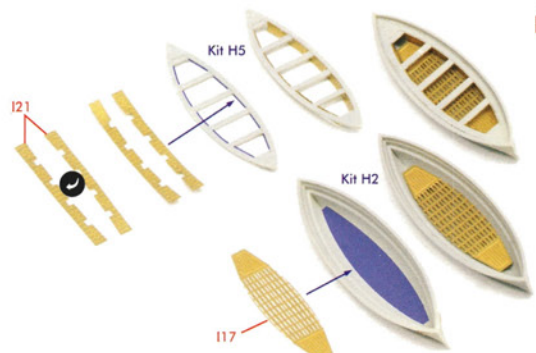

< 25ft Cutter >

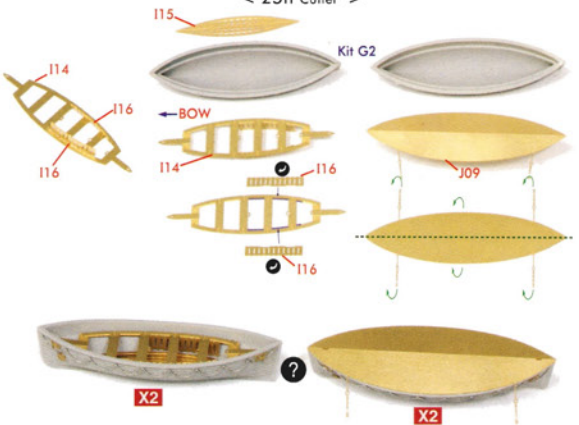

< 27ft Lifeboat >

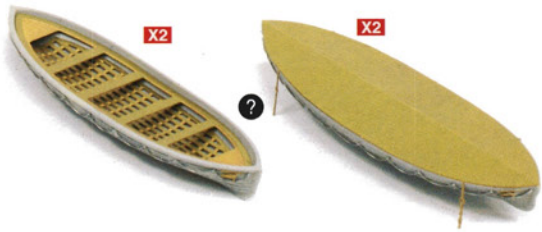
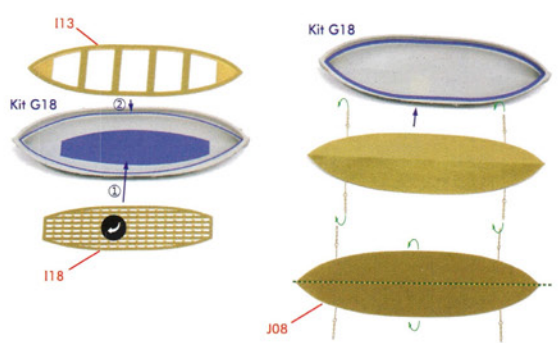

< Boat Chock >

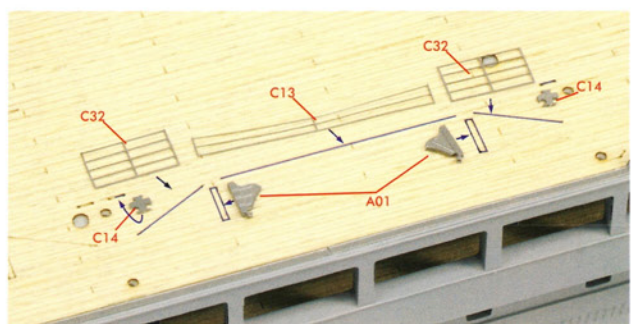
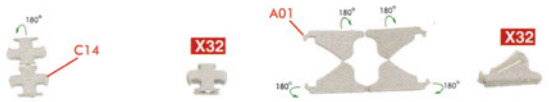

X14

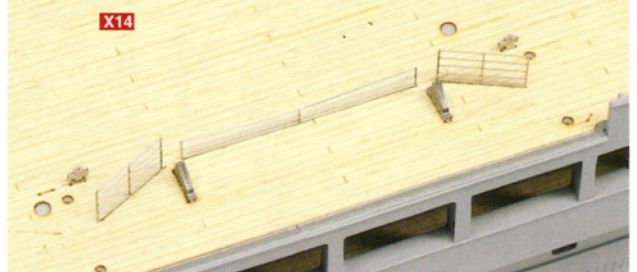

< 1,2 Boat Deck >

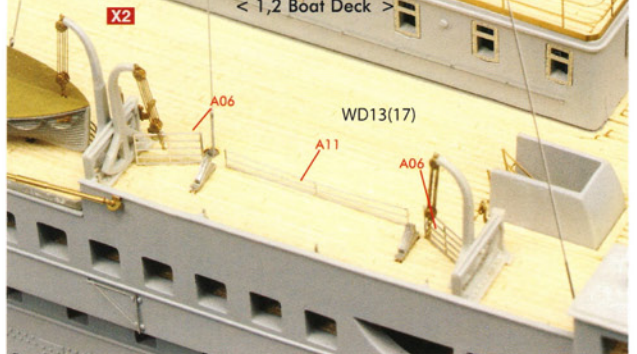

< Davits >

